

## MINI DIN ROUND TYPE CABLE ASSEMBLY

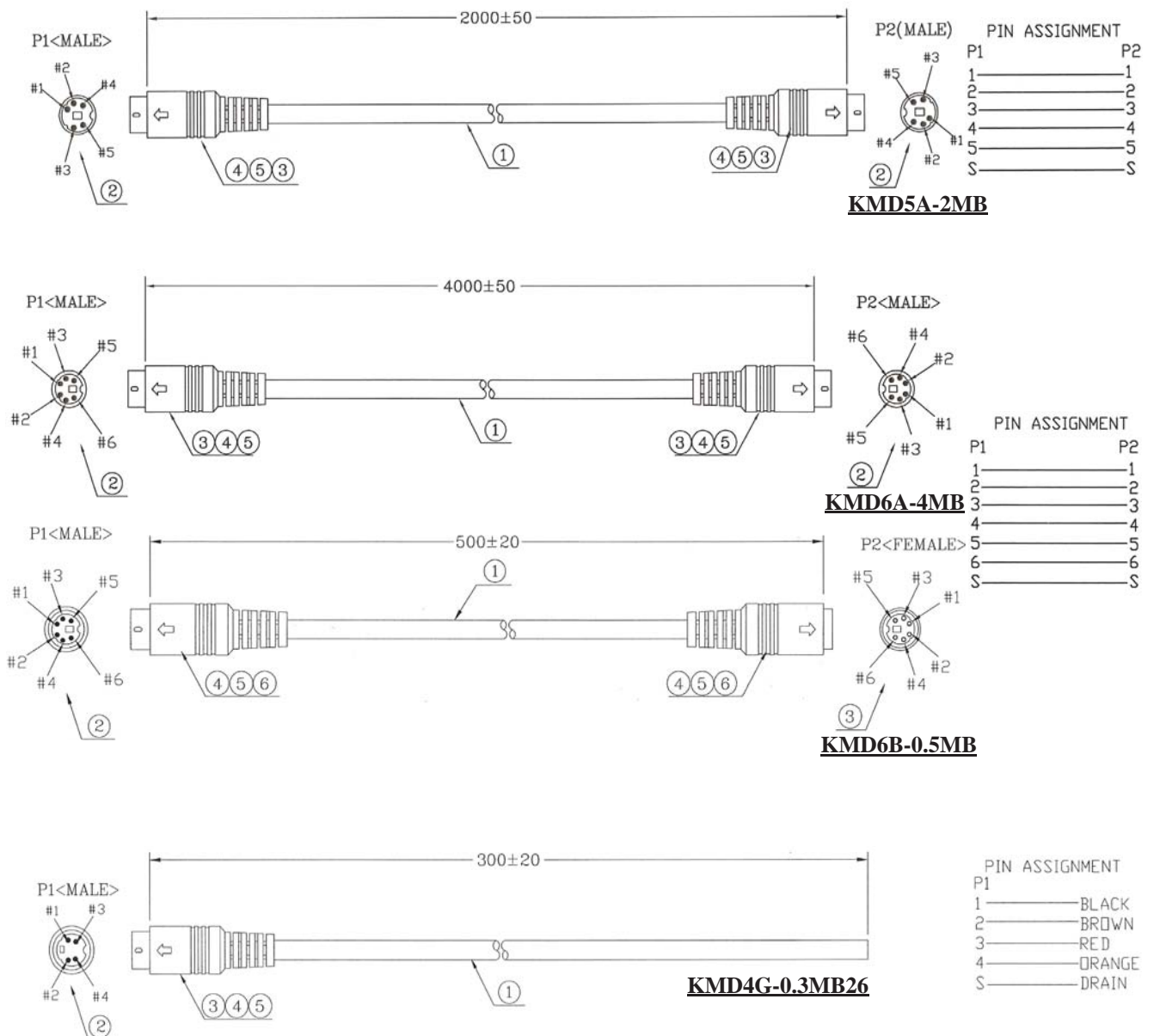

### ORDERING INFORMATION:

P/N **KMD**  $\frac{x}{1}$   $\frac{x}{2}$  -  $\frac{x}{3}$  **M**  $\frac{x}{4}$   $\frac{x}{5}$

1. NO. OF CONTACTS:  
3, 4, 5, 6, 7, 8
2. CONNECTOR TYPES AT 2 ENDS:  
"A" MALE TO MALE  
"B" MALE TO FEMALE  
"G" MALE TO OPEN END  
"H" FEMALE TO OPEN END
3. CABLE LENGTH IN METERS (M)

4. CABLE COLOR:  
"A" GRAY  
"B" BLACK  
"V" BEIGE
5. CABLE AWG TYPE:  
" " AWG28  
"26" AWG26

## MINI DIN APPLE TYPE CABLE ASSEMBLY

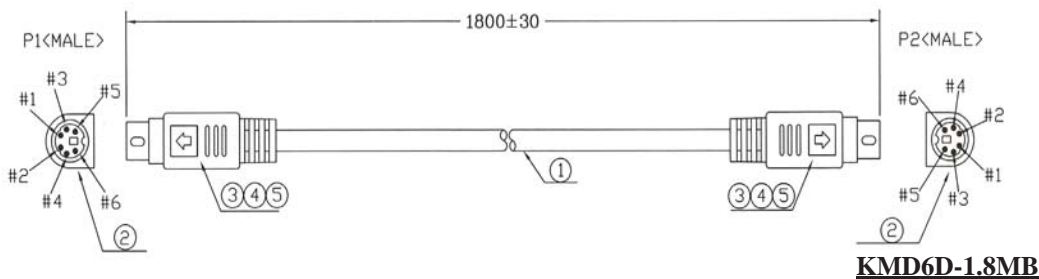

**KMD6D-1.8MB**

### PIN ASSIGNMENT

P1	P2
1	1
2	2
3	3
4	4
5	5
6	6
S	S

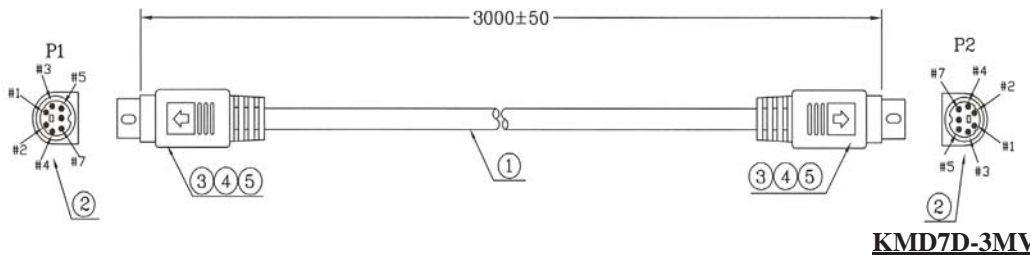

**KMD7D-3MV**

### PIN ASSIGNMENT

P1	P2
1	1
2	2
3	3
4	4
5	5
6	6
7	7
S	S

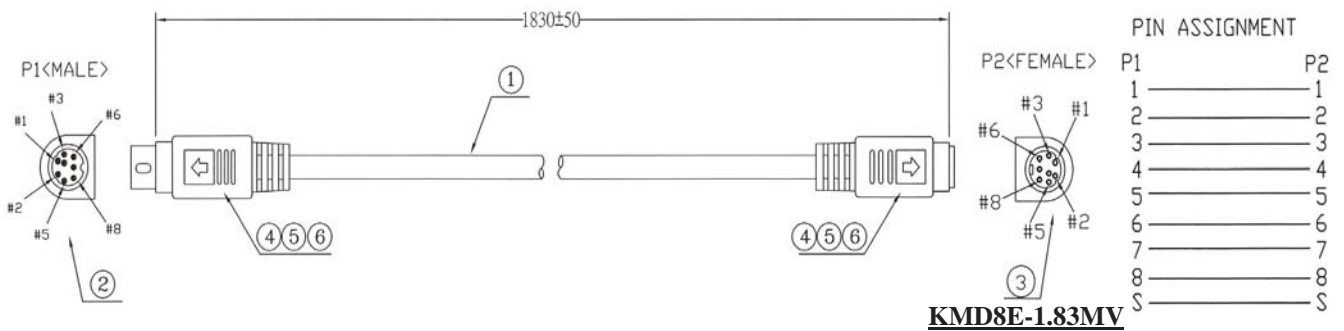

**KMD8E-1.83MV**

### PIN ASSIGNMENT

P1	P2
1	1
2	2
3	3
4	4
5	5
6	6
7	7
8	8
S	S

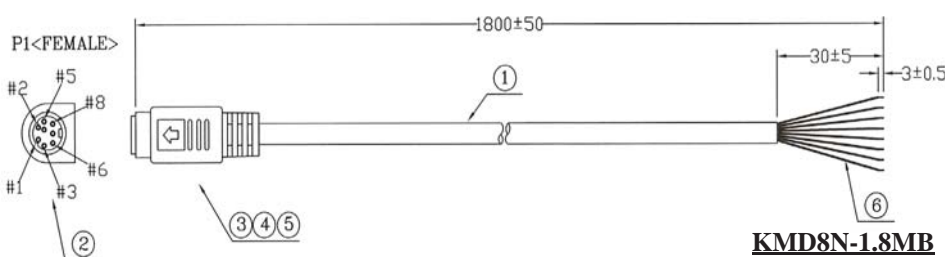

**KMD8N-1.8MB**

### PIN ASSIGNMENT

P1
1
2
3
4
5
6
7
8
S

## ORDERING INFORMATION:

P/N K M D  $\frac{x}{1}$   $\frac{x}{2}$  -  $\frac{x}{3}$  M  $\frac{x}{4}$   $\frac{x}{5}$

1. NO. OF CONTACTS:  
3, 4, 5, 6, 7, 8
2. CONNECTOR TYPES AT 2 ENDS:  
"D" MALE TO MALE  
"E" MALE TO FEMALE  
"M" MALE TO TINNED END  
"N" FEMALE TO TINNED END
3. CABLE LENGTH IN METERS (M)

4. CABLE COLOR:  
"A" GRAY  
"B" BLACK  
"V" BEIGE
5. CABLE AWG TYPE:  
" " AWG28  
"26" AWG26

## MINI DIN 7 PIN DOUBLE ROW TYPE CABLE ASSEMBLY

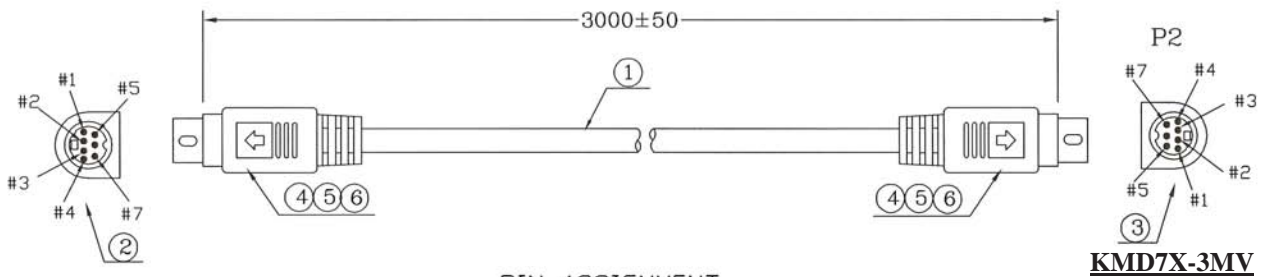
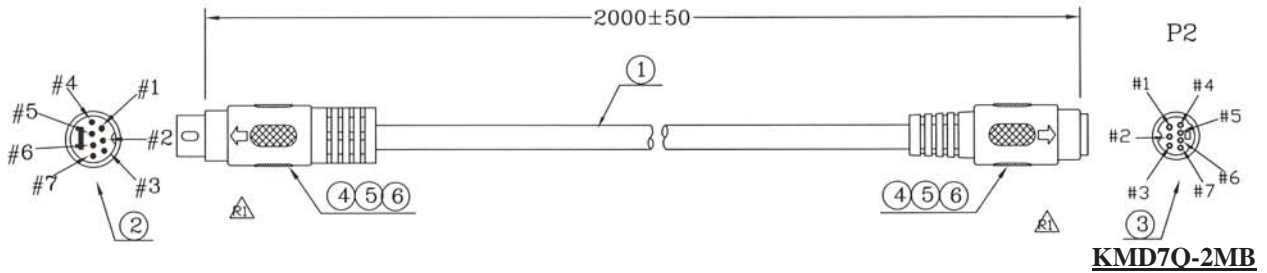
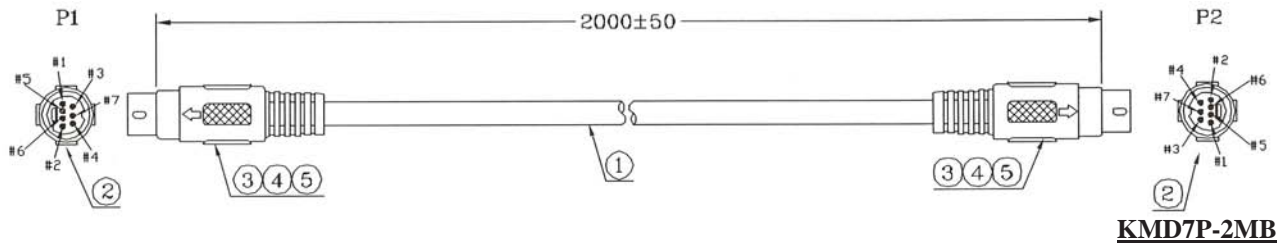

### PIN ASSIGNMENT

P1	P2
1	1
2	2
3	3
4	4
5	5
6	6
7	7
S	S

### ORDERING INFORMATION:

**P/N KMD  $\frac{7}{12} - \frac{x}{3} \frac{M}{4} \frac{x}{5}$**

1. NO. OF CONTACTS:  
"7" 7 PIN DOUBLE ROW TYPE
2. CONNECTOR TYPES AT 2 ENDS:  
"P" ROUND TYPE MALE TO MALE  
"Q" ROUND TYPE MALE TO FEMALE  
"X" APPLE TYPE MALE TO MALE  
"Y" APPLE TYPE MALE TO FEMALE
3. CABLE LENGTH IN METERS (M)
4. CABLE COLOR:  
"A" GRAY  
"B" BLACK  
"V" BEIGE
5. CABLE AWG TYPE:  
" " AWG28  
"26" AWG26

# MINI DIN CABLE ASSEMBLY WITH PC99 FOLLOW PANTONE COLOR

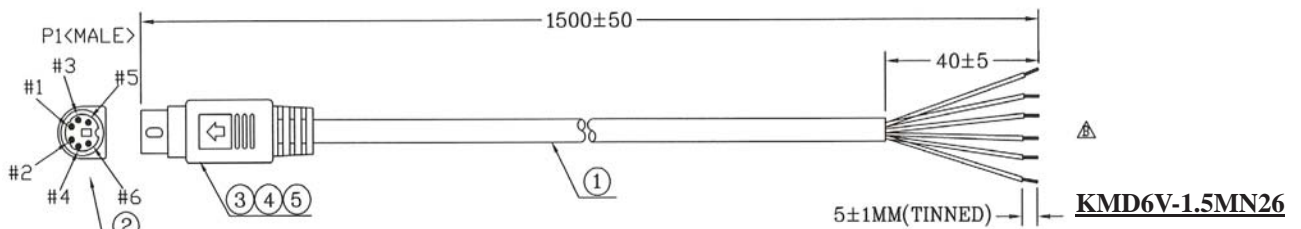
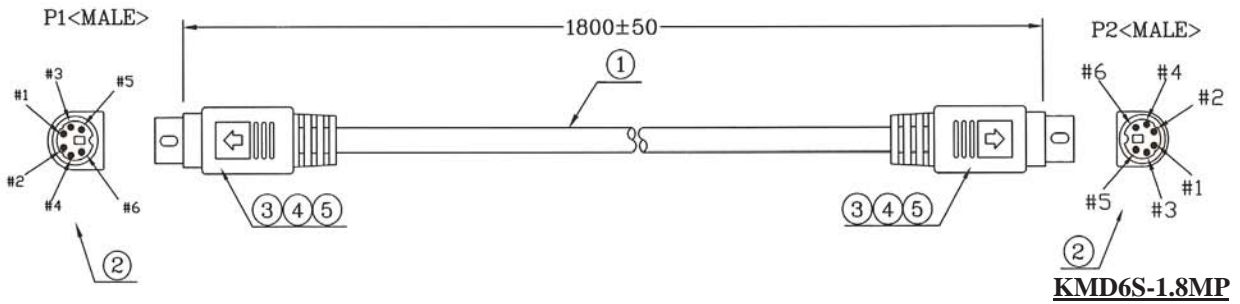
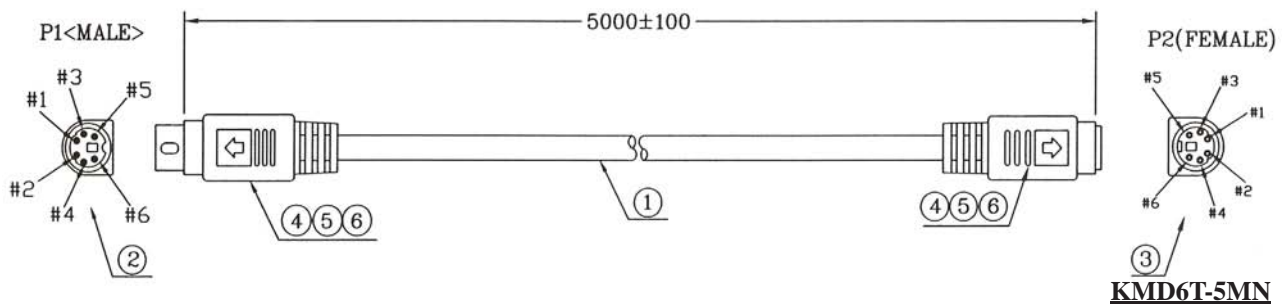

PIN ASSIGNMENT	
P1	P2
1	1
2	2
3	3
4	4
5	5
6	6
S	S

**KMD6T-5MN, KMD6S-1.8MP**

PIN ASSIGNMENT	
P1	△ OPEN
1	YELLOW
2	RED
3	BROWN
4	WHITE
5	GREEN
6	BLACK
S	DRAIN

**KMD6V-1.5MN26**

## ORDERING INFORMATION:

**P/N KMD  $\frac{x}{1} \frac{x}{2} - \frac{x}{3} \frac{M}{4} \frac{x}{5}$**

1. NO. OF CONTACTS:  
4, 6, 8
2. CONNECTOR TYPES AT 2 ENDS:  
"S" MALE TO MALE  
"T" MALE TO FEMALE  
"V" MALE TO TINNED END  
"W" FEMALE TO TINNED END
3. CABLE LENGTH IN METER

4. CONNECTOR COLOR:  
"P" PC99 PURPLE  
"N" PC99 GREEN
5. CABLE AWG TYPE:  
" " AWG28  
"26" AWG26

NOTE: The cable color is BEIGE.

## MINI DIN RIGHT ANGLE TYPE CABLE ASSEMBLY

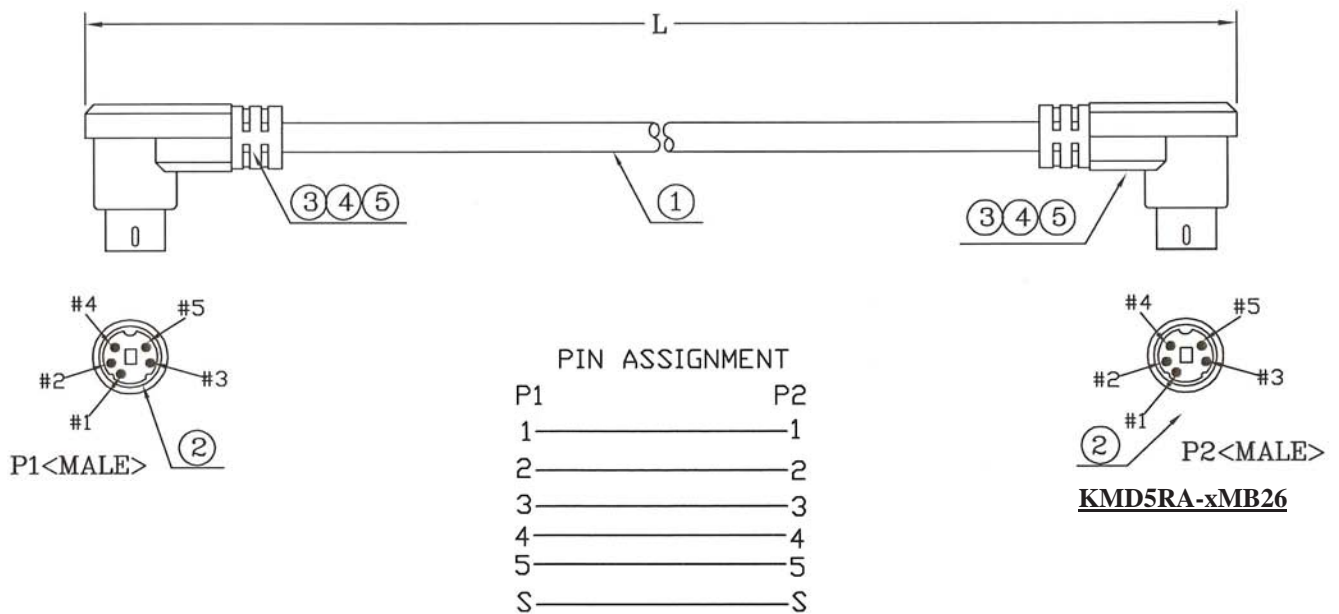

### ORDERING INFORMATION:

**P/N KMD  $\frac{x}{1}$  RA -  $\frac{x}{3}$  M  $\frac{x}{4}$   $\frac{x}{5}$**

**1. NO. OF CONTACTS:**

3, 4, 5, 6, 7, 8

**2. CONNECTOR TYPES AT 2 ENDS:**

"RA" RIGHT ANGLE TYPE MALE TO MALE

**3. CABLE LENGTH IN METERS (M)**

**4. CABLE COLOR:**

"A" GRAY

"B" BLACK

"V" BEIGE

**5. CABLE AWG TYPE:**

" " AWG28

"26" AWG26

## MINI DIN LOCK TYPE M/M & M/F UL2464 SINGLE SHIELDED CABLES

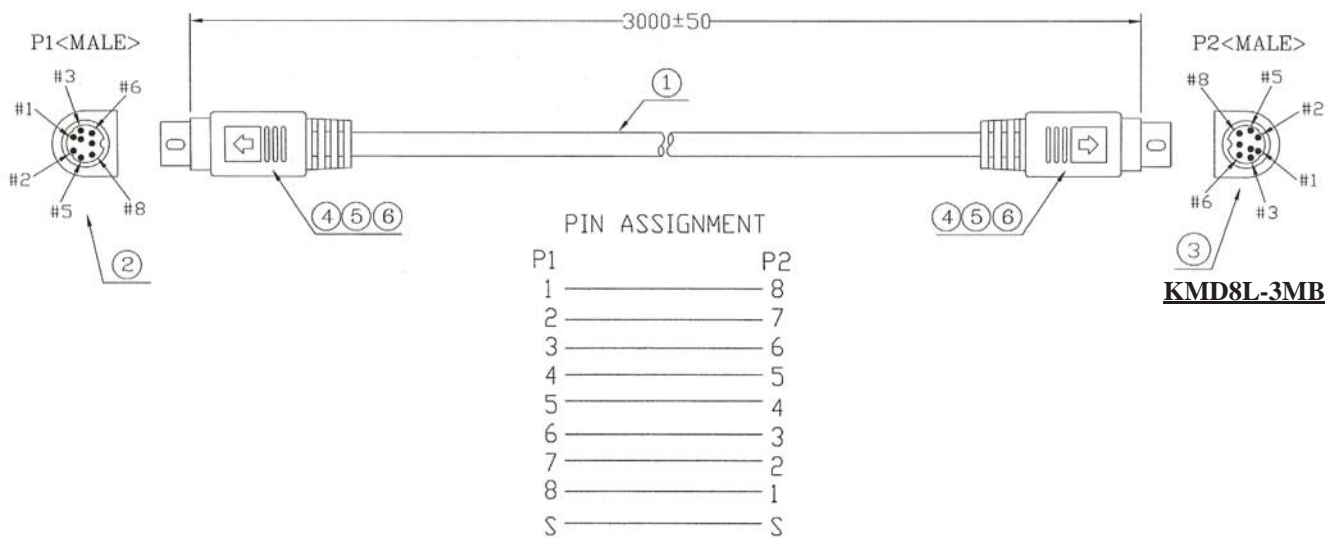
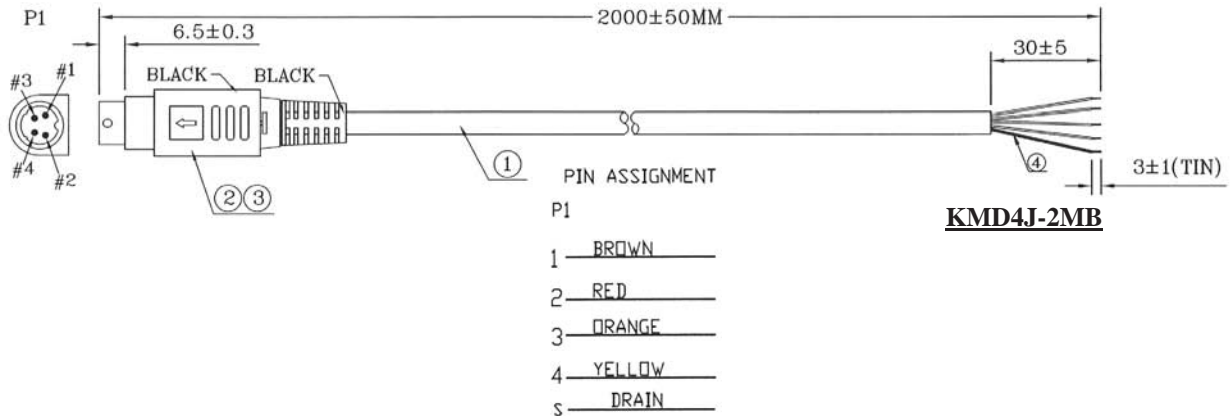

### ORDERING INFORMATION:

P/N KMD  $\frac{x}{1}$   $\frac{x}{2}$  -  $\frac{x}{3}$   $\frac{MB}{4}$

1. NO. OF CONTACTS:

3, 4, 5, 6, 7, 8

2. CONNECTOR TYPES:

"L" LOCK TYPE MALE TO MALE

"K" LOCK TYPE MALE TO FEMALE

"J" LOCK TYPE MALE TO TINNED END

"U" LOCK TYPE FEMALE TO TINNED END

3. LENGTH IN M (METERS)

4. CABLE COLOR:

"B" BLACK

# MINI DIN 6 PIN JACKS TO 1.25MM PITCH 6P HOUSING

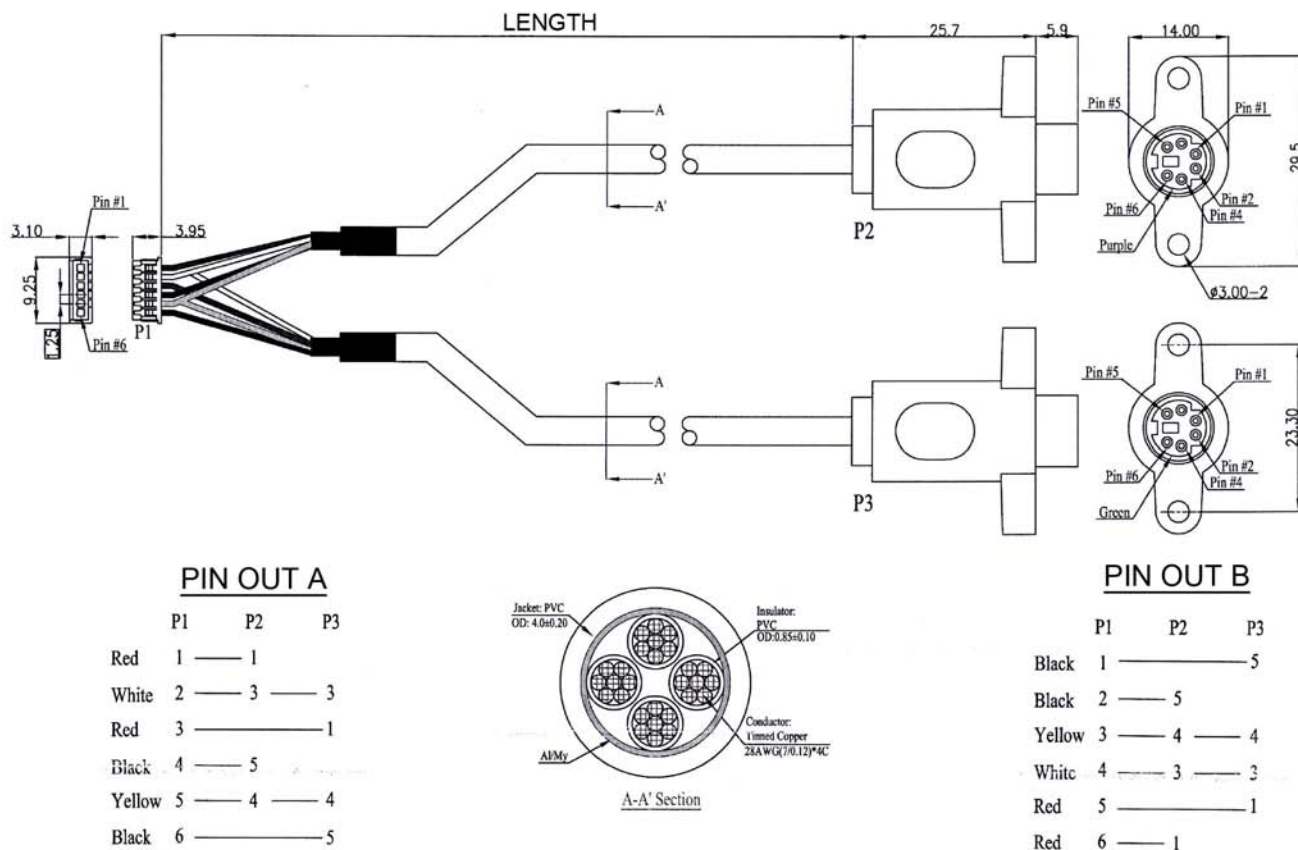

## ORDERING INFORMATION:

### P/N K M D 6 F 6 A - x x M

DOUBLE MINI DIN 6 PIN JACKS TO 1.25MM PITCH 1\*6 PIN HOUSING WITH PIN OUT A LENGTH IN METERS

### P/N K M D 6 F 6 B - x x M

DOUBLE MINI DIN 6 PIN JACKS TO 1.25MM PITCH 1\*6 PIN HOUSING WITH PIN OUT B LENGTH IN METERS

# MINI DIN 6 PIN JACK TO 2.00MM PITCH 6P HOUSING

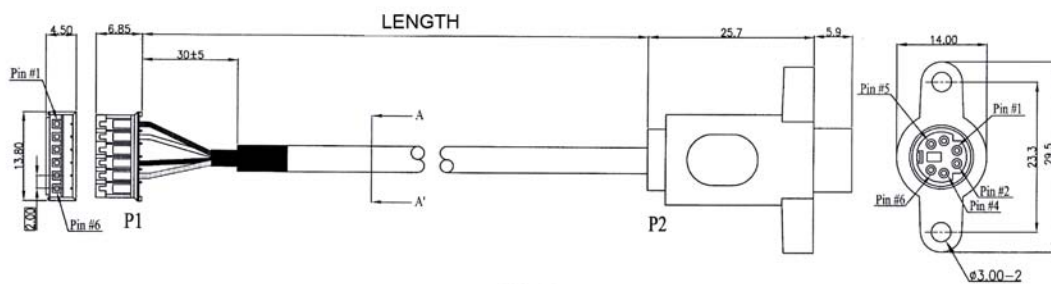

## PIN OUT

P1	P2	
1	1	Red
2	3	White
4	5	Black
5	4	Yellow

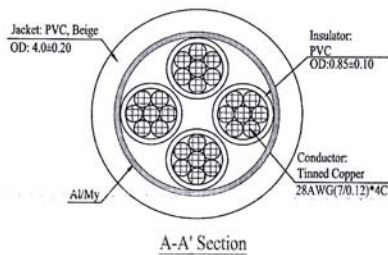

**KMD6F6C-xxM**

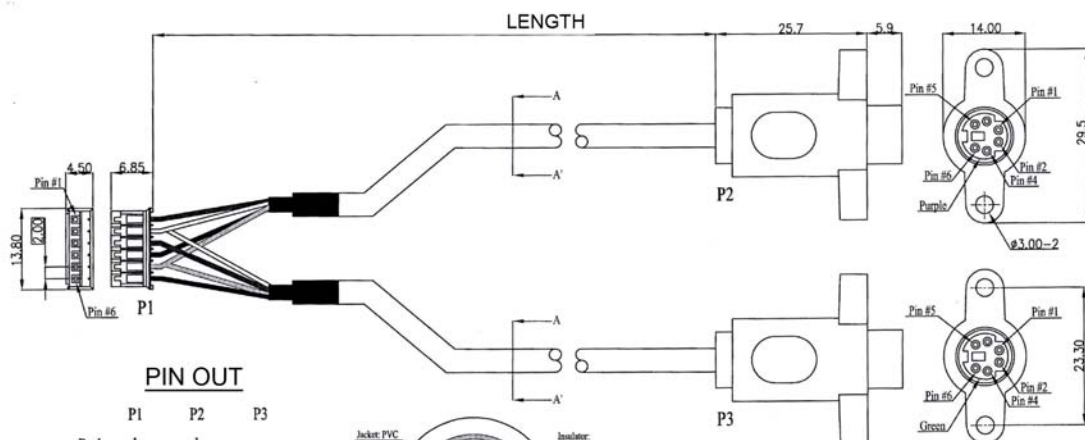

## PIN OUT

P1	P2	P3	
Red	1	1	
White	2	3	3
Red	3	1	
Black	4	5	
Yellow	5	4	4
Black	6	5	

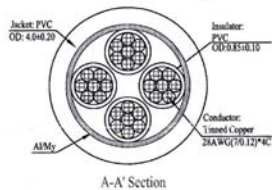

**KMD6F6D-xxM**

## ORDERING INFORMATION:

**P/N K M D 6 F 6 C - x x M**

MINI DIN 6 PIN JACK TO  
2.00MM PITCH 1\*6 PIN HOUSING LENGTH IN METERS

**P/N K M D 6 F 6 D - x x M**

DOUBLE MINI DIN 6 PIN JACKS TO  
2.00MM PITCH 1\*6 PIN HOUSING LENGTH IN METERS

# MINI DIN 6 PIN PLUG/JACK TO 2.54MM PITCH HOUSING

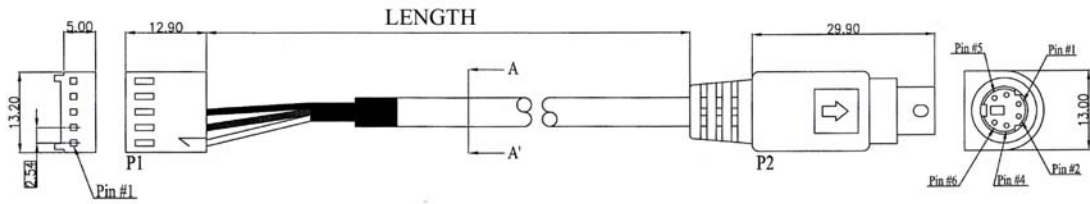

**KMD6M05G-xxM**

**PIN OUT**

P1	P2	
1	6	White
2	4	Red
3	2	Black

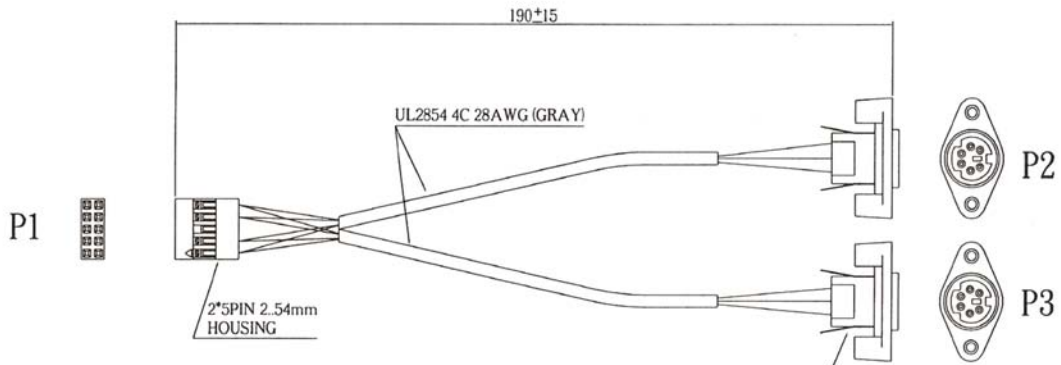
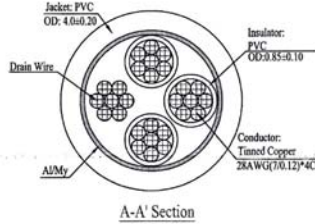

**KMD6F10H-xxM**

**PIN OUT:**

HOUSING(P1)	MINI6(P2)	MINI6(P3)
1	4	
2	3	
4	1	
5	5	
6	4	
7	3	
9	1	
10	5	

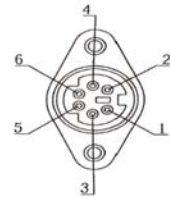

**ORDERING INFORMATION:**

**P/N KMD6M05G - x x M**

MINI DIN 6 PIN PLUG TO  
2.54MM 1\*5 PIN HOUSING LENGTH IN METERS

**P/N KMD6F10H - x x M**

DOUBLE MINI DIN 6 PIN JACKS TO  
2\*5 PIN HOUSING LENGTH IN METERS

# MINI DIN 6 PIN JACK TO PLUG CABLE ASSEMBLY

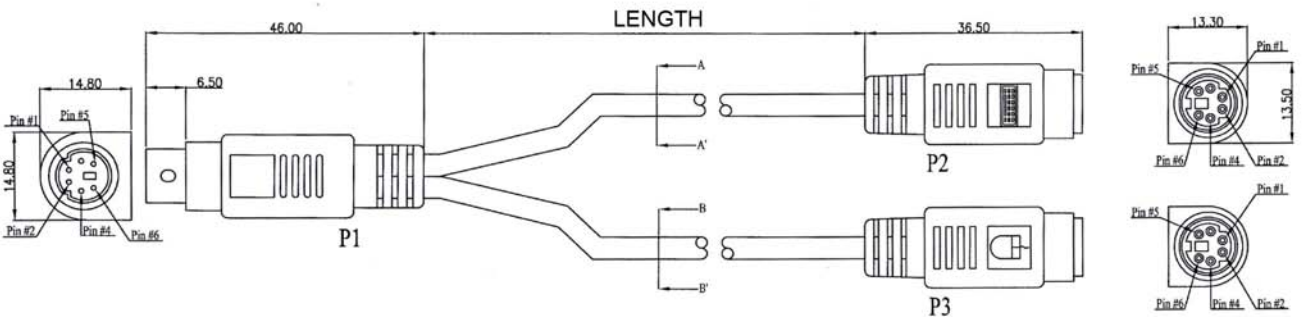
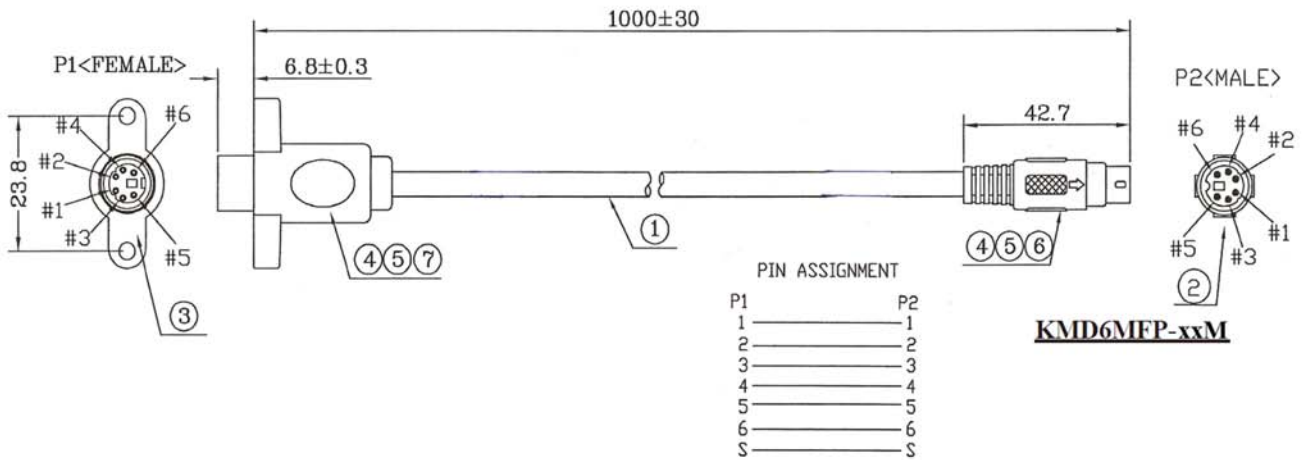

## PIN OUT

P1	P2	P3
1	1	
2	2	1
3	3	3
4	4	4
5	5	4
6	6	5

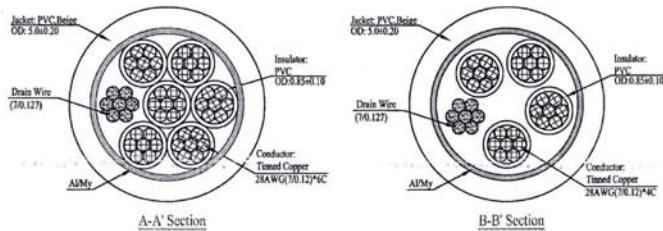

## ORDERING INFORMATION:

### P/N KMD6MFP-xxM

MINI DIN 6 PIN JACK TO  
MINI DIN 6 PIN PLUG LENGTH IN METERS

### P/N KMD6MFF-xxM

DOUBLE MINI DIN 6 PIN JACKS TO  
MINI DIN 6 PIN PLUG LENGTH IN METERS

# MINI DIN 4 PIN JACK & RCA JACK TO 2.00MM PITCH 10P HOUSING

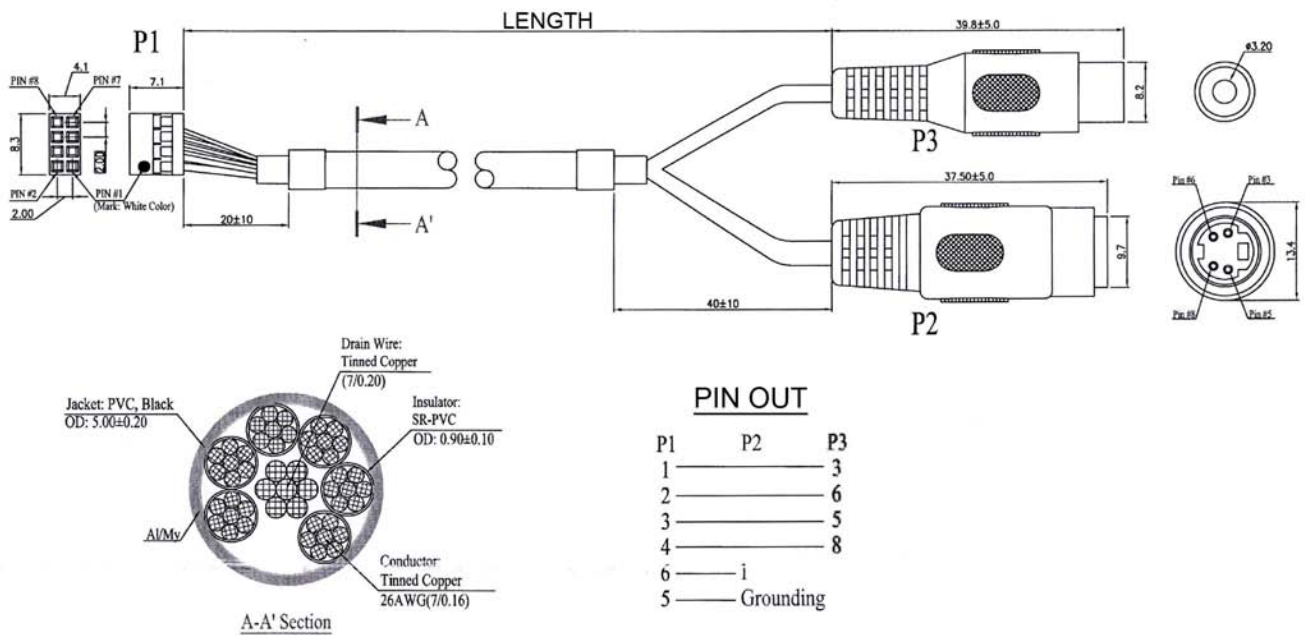

## ORDERING INFORMATION:

**P/N K M D 4 F R 8 H - x x M**

MINI DIN 4 PIN JACK & RCA JACK TO 2.00MM PITCH 2\*5 PIN HOUSING LENGTH IN METERS

# MINI DIN 6 PIN CABLE ASSEMBLY

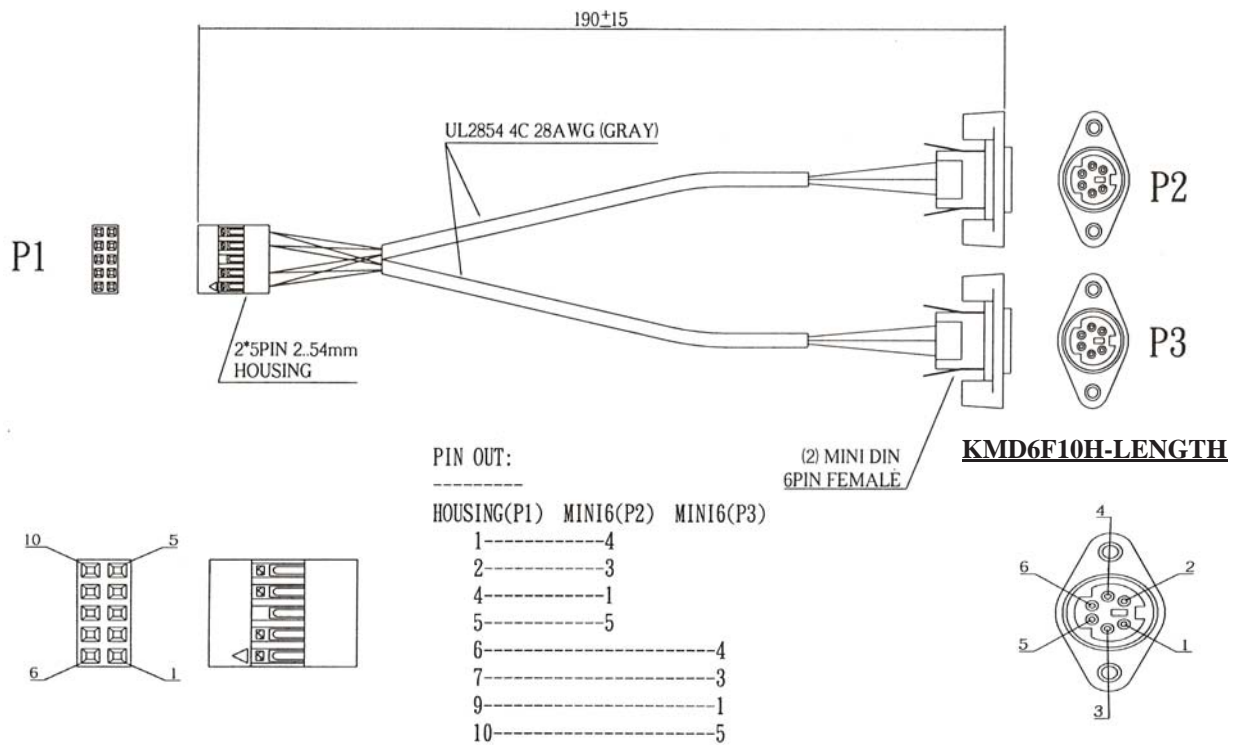

## ORDERING INFORMATION:

**P/N KMD6F10H-LENGTH**

DOUBLE MINI DIN 6 PIN SOCKETS TO 2.54MM 2x5 PIN HOUSING LENGTH IN METERS

## MINI DIN 6 PIN FEMALE CABLE WITH SLOT BRACKET

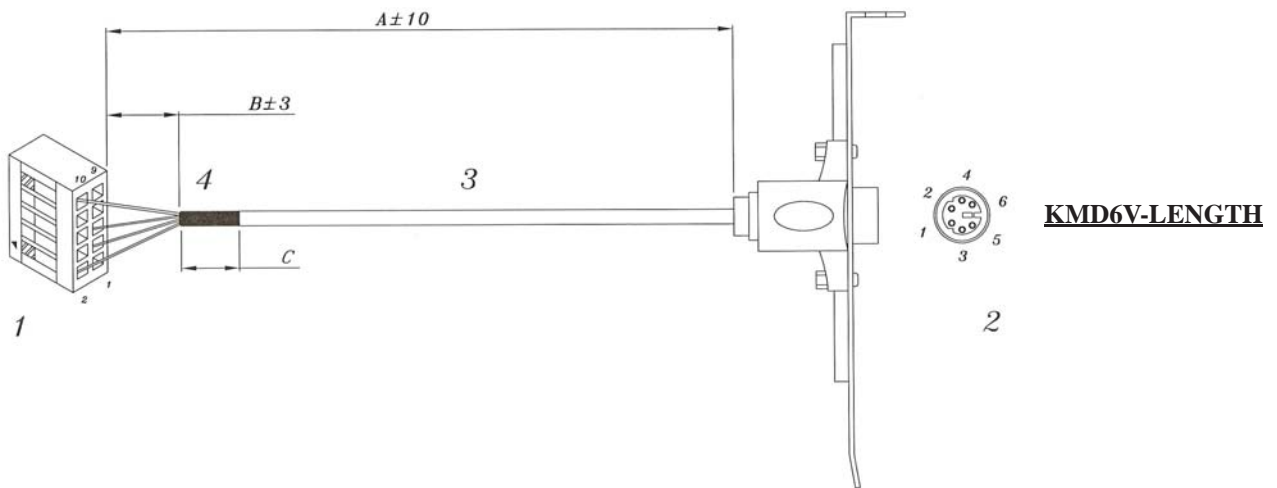
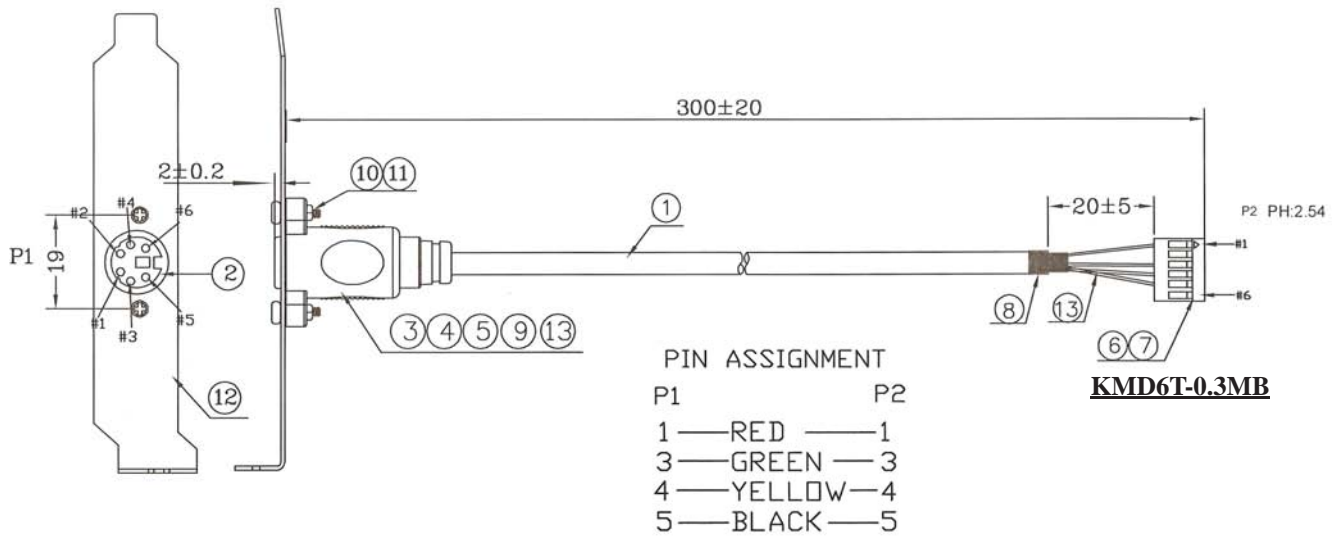

### ORDERING INFORMATION:

#### **P/N K M D 6 T - x x M B**

MINI DIN 6 PIN FEMALE CONNECTOR WITH SLOT BRACKET  
TO 2.54MM 1x6 PIN HOUSING AWG28/4C IN BLACK

#### **P/N K M D 6 V - x x M V**

MINI DIN 6 PIN FEMALE CONNECTOR WITH SLOT BRACKET  
TO 2.54MM 2x5 PIN HOUSING AWG28/4C IN BEIGE

## MINI DIN 6 PIN SPLITTER CABLE ASSEMBLY

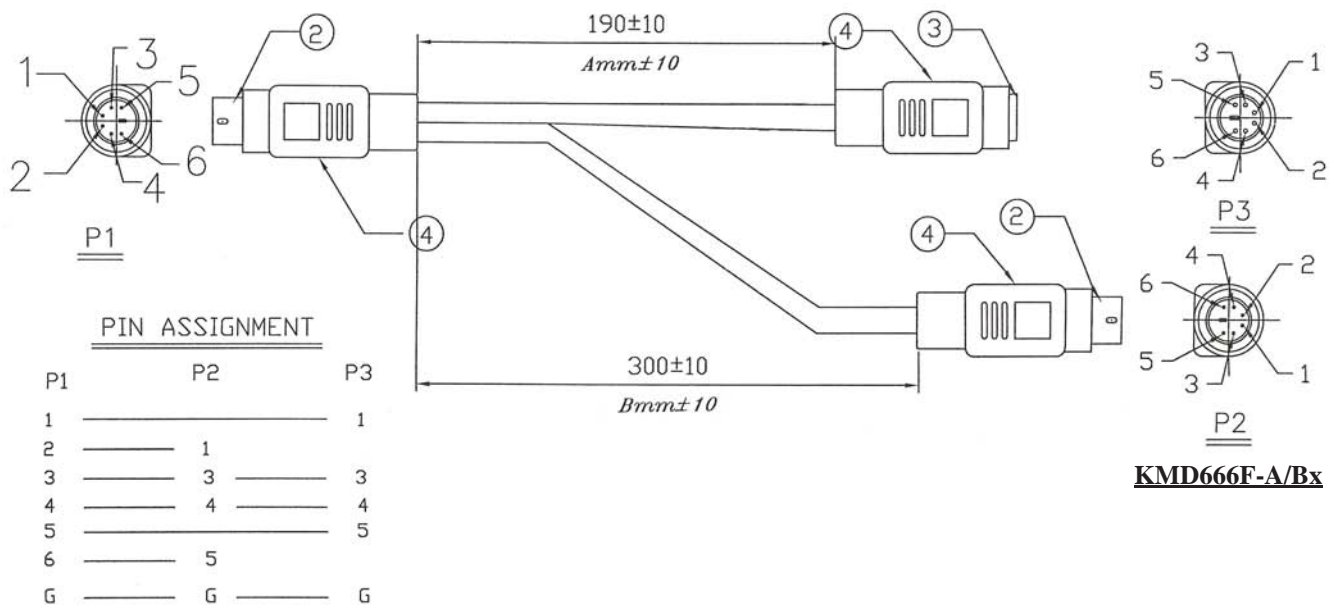
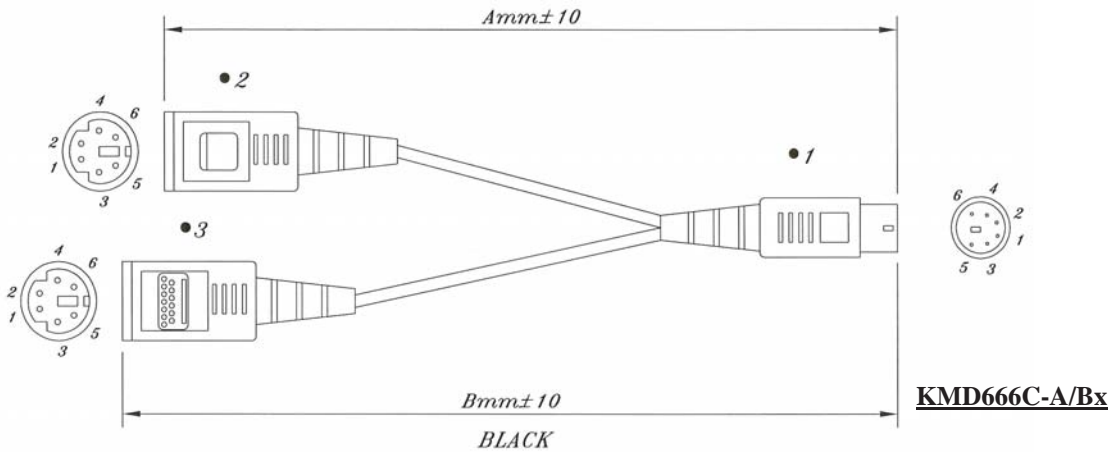

### PIN ASSIGNMENT

P1	P2	P3
1	1	1
2	1	
3	3	3
4	4	4
5	5	5
6	5	
G	G	G

### ORDERING INFORMATION:

**P/N K M D 6 6 6  $\frac{x}{1}$  -  $\frac{A/B}{2}$   $\frac{x}{3}$**

1. SPLITTER CABLE TYPE:  
 "C" MD6M(PLUG) TO 2\*MD6F(JACK)  
 "F" MD6M(PLUG) TO MD6F(JACK) &  
 MD6M(PLUG)
2. CABLE LENGTH A/B IN METERS
3. CABLE COLOR:  
 "B" BLACK  
 "V" BEIGE

## MINI DIN 6 PIN JACK TO 2.54MM PITCH HOUSING

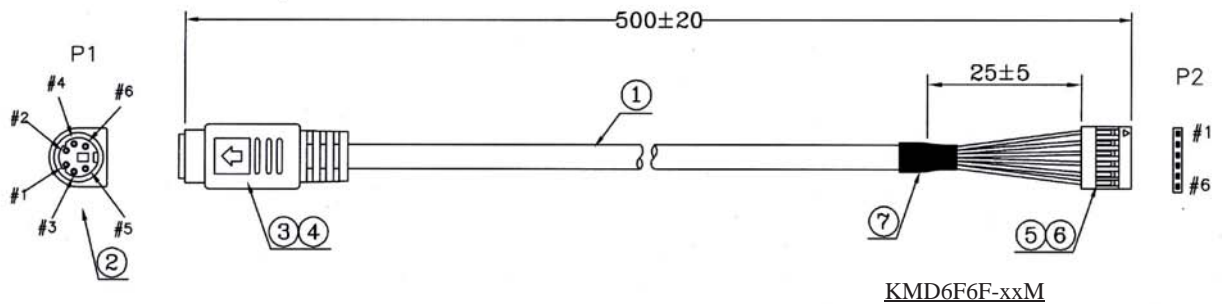
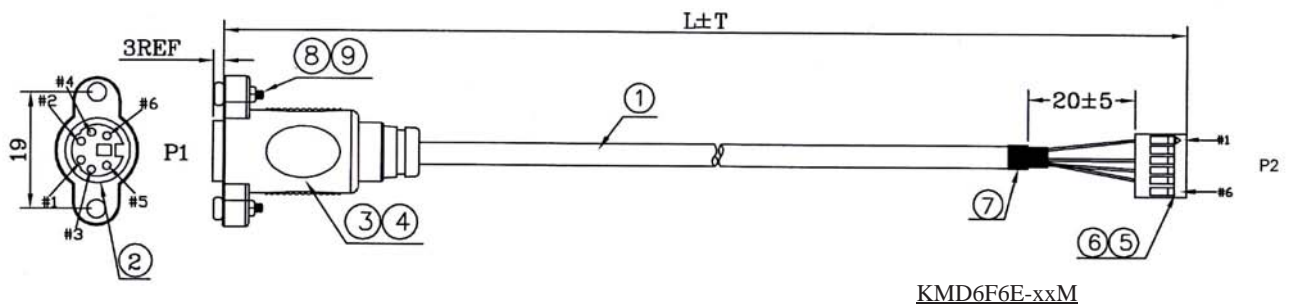

### ORDERING INFORMATION:

#### **P/N K M D 6 F 6 E - x x M**

MINI DIN 6 PIN JACK TO  
2.54MM PITCH 1\*6 PIN HOUSING LENGTH IN METERS

#### **P/N K M D 6 F 6 F - x x M**

MINI DIN 6 PIN JACK TO  
2.54MM PITCH 1\*6 PIN HOUSING LENGTH IN METERS

## MINI DIN CABLES (1)

**P/N KAV749N-LENGTH**  
3 PIN MINI DIN PLUG TO  
2\*RCA PLUGS



**P/N KAV708N-LENGTH**  
4 PIN MINI DIN PLUG TO  
RCA JACK



**P/N KAV742G-LENGTH**  
4 PIN MINI DIN PLUG TO  
4 PIN MINI DIN PLUG  
GOLD PLATED TYPE



**P/N KAV741G-LENGTH**  
4 PIN MINI DIN PLUG TO  
2\*RCA PLUGS  
GOLD PLATED TYPE



**P/N KAV308G-LENGTH**  
4P MINI DIN METAL PLUG TO  
4P MINI DIN METAL PLUG  
GOLD PLATED TYPE



**P/N KAV761G-LENGTH**  
4P MINI DIN METAL PLUG TO  
4P MINI DIN METAL JACK  
GOLD PLATED TYPE



**P/N KAV362N-LENGTH**  
4 PIN MINI DIN PLUG TO  
2\*RCA JACKS



**P/N KAV363N-LENGTH**  
4 PIN MINI DIN PLUG TO  
2\*4P MINI DIN JACKS



**P/N KAV740N-LENGTH**  
4 PIN MINI DIN PLUG TO  
2\*RCA PLUGS



**P/N KAV746N-LENGTH**  
4 PIN MINI DIN PLUG TO  
RCA PLUG



**P/N KAV747N-LENGTH**  
4 PIN MINI DIN JACK TO  
6 PIN MINI DIN PLUG



**P/N KAV794N-LENGTH**  
4P MINI DIN JACK TO  
STRIPPED & TINNED END



## MINI DIN CABLES (2)

### P/N KAV322N-LENGTH

4P MINI DIN PLUG +  
3.5MM STEREO PLUG TO  
4P MINI DIN PLUG +  
3.5MM STEREO PLUG



### P/N KAV745N-LENGTH

4 PIN MINI DIN PLUG TO  
3\*RCA PLUGS



### P/N KAV077N-LENGTH

5 PIN MINI DIN PLUG TO  
3\*RCA PLUGS



### P/N KAV081N-LENGTH

6P MINI DIN PLUG TO  
3.5MM STEREO PLUG &  
3.5MM STEREO JACK



### P/N KAV065N-LENGTH

8P MINI DIN PLUG TO  
3.5MM STEREO PLUG



### P/N KAV128N-LENGTH

8P MINI DIN PLUG TO  
2\*RCA PLUGS



### P/N KAV130N-LENGTH

8P MINI DIN PLUG TO  
2\*RCA PLUGS



### P/N KAV722N-LENGTH

8P MINI DIN PLUG TO  
4\*RCA JACKS



### P/N KAV954N-LENGTH

KEYBOARD CABLE DIN  
5P MALE TO  
6P MALE 5C MOLDED



### P/N KAV366N-LENGTH

6P MINI DIN PLUG TO  
4P MINI DIN JACK & RCA JACK



### P/N KAV367N-LENGTH

7P MINI DIN PLUG TO  
2\*RCA PLUGS



### P/N KAV953N-LENGTH

KEYBOARD CABLE MINI DIN  
6P MALE TO  
FEMALE 7C MOLDED



## MINI DIN CABLES (3)

**P/N KAV910G-LENGTH**  
7P MINI DIN PLUG (2 ROWS)  
TO 4P MINI DIN JACK  
GOLD PLATED



**P/N KAV909G-LENGTH**  
4P MINI DIN PLUG  
TO 7P MINI DIN PLUG (2 ROWS)  
GOLD PLATED



**P/N KAV858N-LENGTH**  
RCA PLUG  
TO  
7P MINI DIN PLUG (PIN=2 ROWS)



**P/N KAV883N-LENGTH**  
7P MINI DIN PLUG (PIN =2 ROWS)  
TO 2\*RCA PLUGS



**P/N KAV885N-LENGTH**  
7P MINI DIN PLUG (PIN =2 ROWS)  
TO 3\*RCA PLUGS



**P/N KAV884N-LENGTH**  
7P MINI DIN PLUG (PIN =3 ROWS)  
TO 3\*RCA PLUGS



**P/N KAV834N-LENGTH**  
3.5MM STEREO PLUG  
TO  
7P MINI DIN PLUG (PIN =3 ROWS)



**P/N KAV859G-LENGTH**  
4P MINI DIN PLUG  
TO RCA PLUG  
GOLD PLATED



**P/N KAV897G-LENGTH**  
4P MINI DIN PLUG  
TO 4P MINI DIN PLUG  
GOLD PLATED



**P/N KAV827G-LENGTH**  
4P MINI DIN PLUG  
TO 3\*RCA PLUGS (OD=3.5/10.5MM)  
GOLD PLATED



**P/N KAV886N-LENGTH**  
HDDB15P & 6P MINI DIN (MOUSE) &  
6P MINI DIN (KEYBOARD)  
MALE TO MALE



**P/N KAV887N-LENGTH**  
HDDB15P MALE & 2\*6P MINI DIN MALES  
TO  
HDDB15P FEMALE & 2\*6P MINI DIN PLUGS



## MINI DIN CABLES (4)

**P/N KAV937N-LENGTH**  
USB A MALE  
TO 4P MINI DIN PLUG



**P/N KAV946N-LENGTH**  
KEYBOARD CABLE MINI DIN 6P MALE  
TO  
MALE 7C MOLDED (COIL CABLE)



**P/N KAV947N-LENGTH**  
KEYBOARD CABLE MINI DIN 6P MALE  
TO  
FEMALE 7C MOLDED (COIL CABLE)



**P/N KAV835N-LENGTH**  
USB A FEMALE  
TO 6P MINI DIN MALE



**P/N KAV932N-LENGTH**  
8P MINI DIN PLUG  
TO 3\*RCA PLUGS



**P/N KAV944N-LENGTH**  
KEYBOARD CABLE DIN 5P MALE  
TO  
MINI DIN 6P FEMALE 5C MOLDED  
(COIL CABLE)



**P/N KAV836N-LENGTH**  
USB A MALE  
TO 6P MINI DIN FEMALE

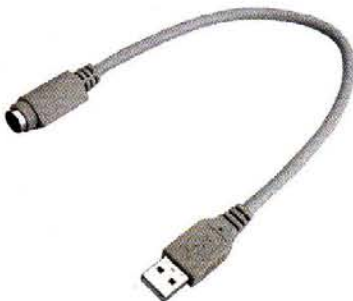

**P/N KAV958G-LENGTH**  
4P MINI DIN PLUG  
TO 2\*RCA PLUGS  
GOLD PLATED



**P/N KAV945N-LENGTH**  
KEYBOARD CABLE DIN 5P FEMALE  
TO  
MINI DIN 6P MALE 5C MOLDED  
(COIL CABLE)



**P/N KAV955G-LENGTH**  
4P MINI DIN PLUG  
TO PLUG  
GOLD PLATED



**P/N KAV956G-LENGTH**  
4P MINI DIN PLUG  
TO RCA PLUG  
GOLD PLATED



**P/N KAV957G-LENGTH**  
4P MINI DIN PLUG  
TO RCA JACK  
GOLD PLATED



## MINI DIN PLUG TO BNC PLUG / RJ45 PLUG

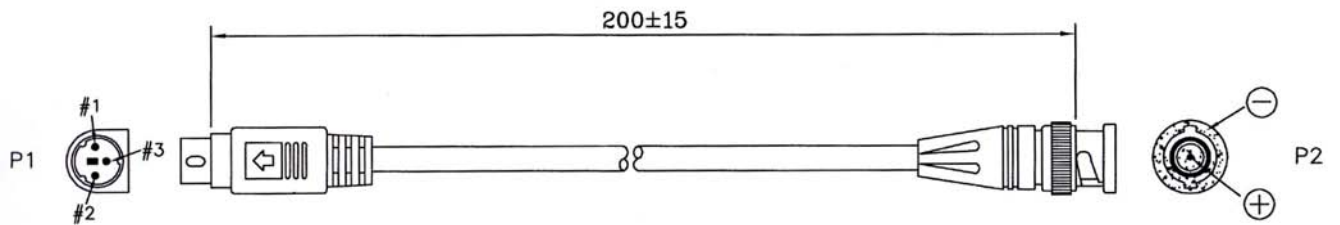

**KMD3BNC-xxMB**

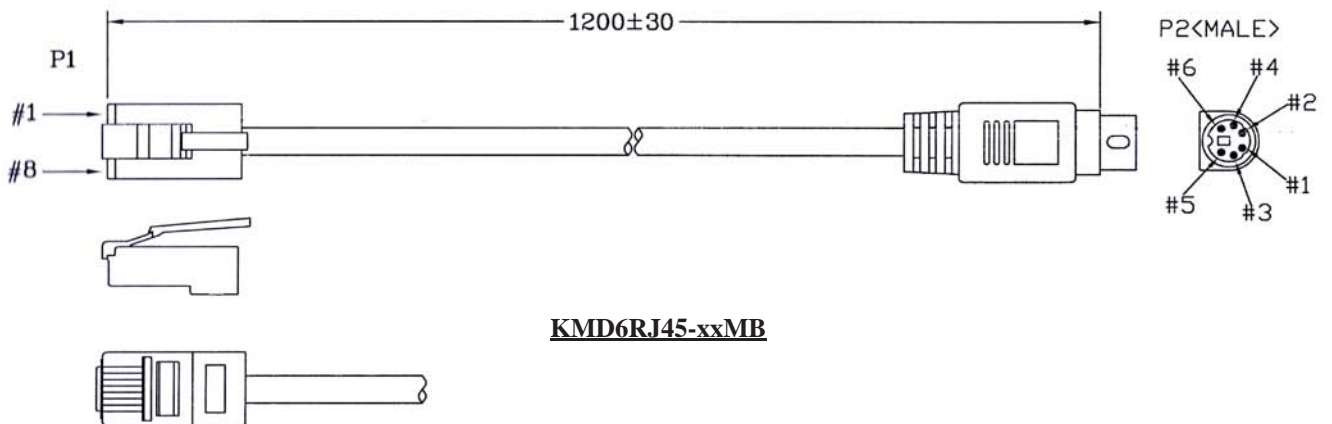

**KMD6RJ45-xxMB**

### ORDERING INFORMATION:

**P/N K M D 3 B N C - x x M B**

MINI DIN 3 PIN PLUG TO BNC PLUG CABLE LENGTH IN METERS

**P/N K M D 6 R J 4 5 - x x M B**

MINI DIN 6 PIN PLUG TO RJ45 (8P8C) PLUG LENGTH IN METERS