

USB3.0 A/M TO USB3.0 A/M CABLE

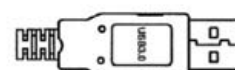
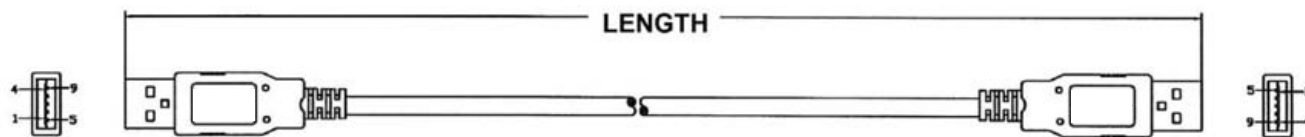

USB3.0 AM	USB3.0 AM	COLOR
1	1	RED
2	2	WHITE
3	3	GREEN
4	4	BLACK
5	8	YELLOW
6	9	BLUE
7	7	DRAIN
8	5	ORANGE
9	6	PURPLE
SHELL	SHELL	BRAID

ORDERING INFORMATION:

P/N K 0 7 M - x x M U
 1 2 3

1. CONNECTORS AT 2 ENDS:
 "M" USB3.0 A TYPE MALE TO
 USB3.0 A TYPE MALE
2. CABLE LENGTH IN METER:
 0.5M, 1M, 2M, 3M, ...etc.
3. CABLE COLOR:
 "U" BLUE

USB3.0 A/M TO USB3.0 B/M CABLE

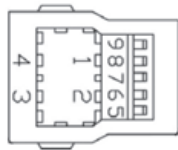
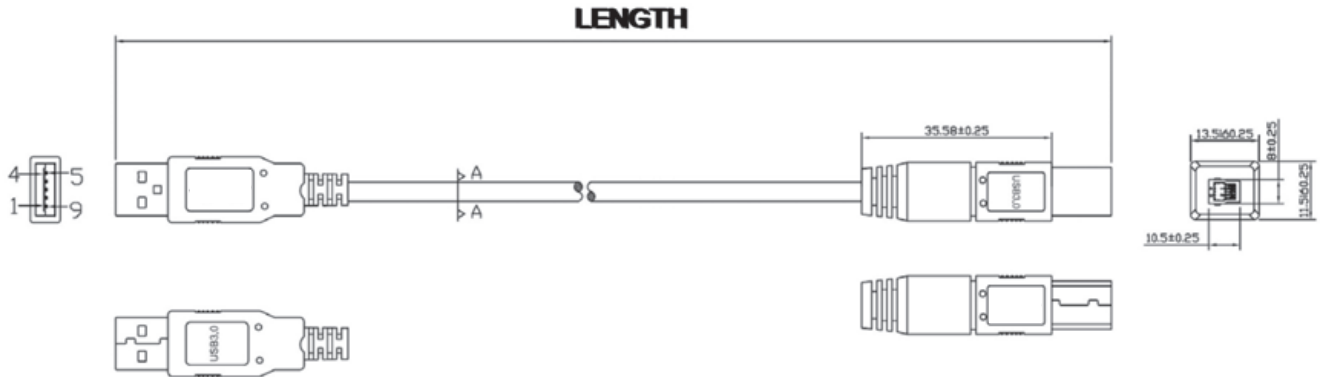

USB3.0 AM	USB3.0 BM	COLOR
1	1	RED(PWR)
2	2	WHITE(UTP_D-)
3	3	GREEN(UTP_D+)
4	4	BLACK(GND_PWRrt)
5	5	YELLOW(SDP1-)
6	6	BLUE(SDP1+)
7	7	DF DP1_Drain DP2_Drain
8	8	ORANGE(SDP2-)
9	9	PURPLE(SDP2+)
SHELL	SHELL	Braid

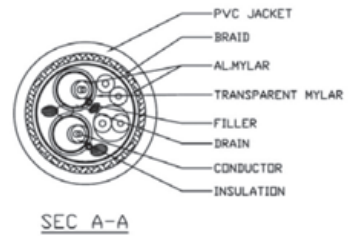

ORDERING INFORMATION:

P/N **K 0 7 N - x x M U**
 1 2 3

- CONNECTORS AT 2 ENDS:
"N" USB3.0 A TYPE MALE TO
USB3.0 B TYPE MALE
- CABLE LENGTH IN METER:
0.5M, 1M, 2M, 3M, ...etc.
- CABLE COLOR:
"U" BLUE

USB3.0 B/M TO USB3.0 B/M CABLE

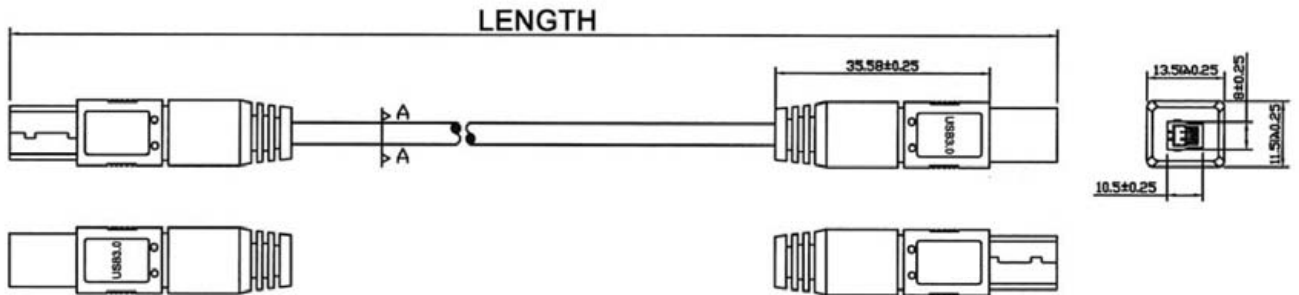

USB3.0 BM	USB3.0 BM	COLOR
1	1	RED(PWR)
2	2	WHITE(UTP_D-)
3	3	GREEN(UTP_D+)
4	4	BLACK(GND_PWRrt)
5	8	YELLOW(SDP1-)
6	9	BLUE(SDP1+)
7	7	DRAIN(SDP1_Drain) (SDP2_Drain)
8	5	ORANGE(SDP2-)
9	6	PURPLE(SDP2+)
SHELL	SHELL	BRAID

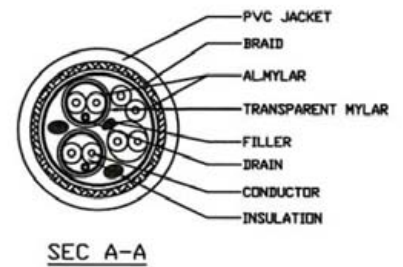

ORDERING INFORMATION:

P/N K 0 7 P - x x M U
 1 2 3

- CONNECTORS AT 2 ENDS:
"P" USB3.0 B TYPE MALE TO
USB3.0 B TYPE MALE
- CABLE LENGTH IN METER:
0.5M, 1M, 2M, 3M, ...etc.
- CABLE COLOR:
"U" BLUE

USB3.0 A/M TO USB3.0 A/F CABLE

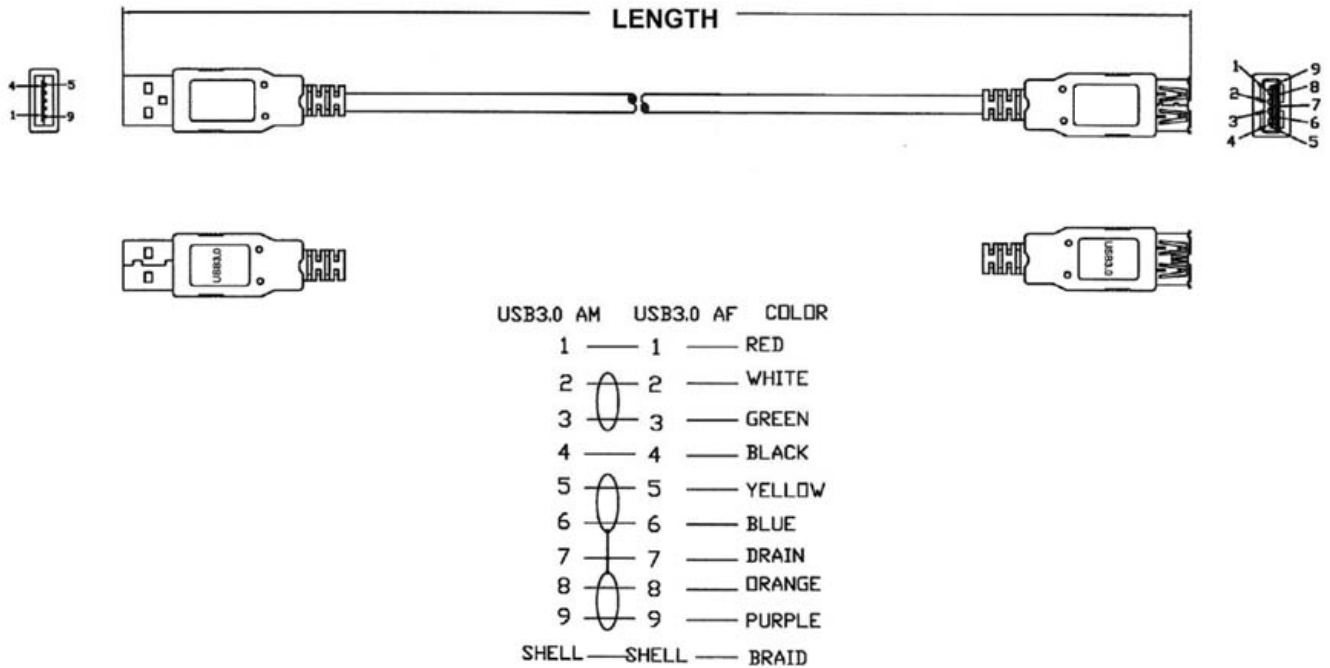

ORDERING INFORMATION:

P/N **K 0 7 Q - x x M U**
 1 2 3

1. CONNECTORS AT 2 ENDS:
 "Q" USB3.0 A TYPE MALE TO
 USB3.0 A TYPE FEMALE
2. CABLE LENGTH IN METER:
 0.5M, 1M, 2M, 3M, ...etc.
3. CABLE COLOR:
 "U" BLUE

USB3.0 A/F TO USB3.0 A/F CABLE

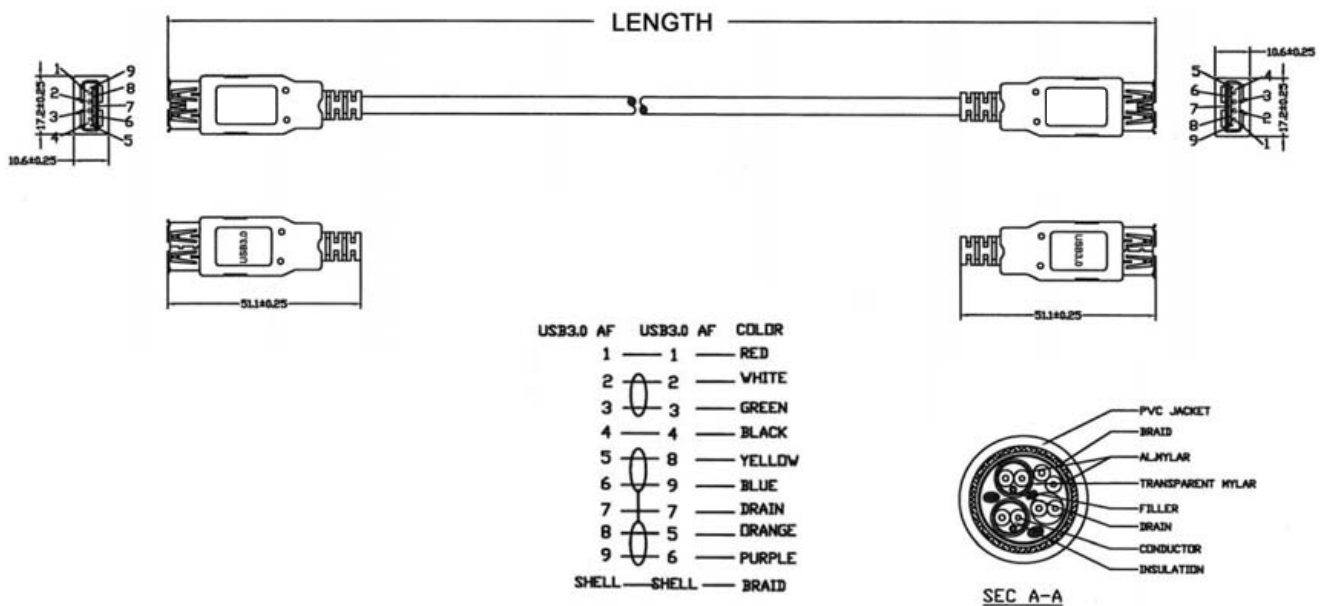

ORDERING INFORMATION:

P/N **K 0 7 T - x x M U**
 $\frac{1}{1} \quad \frac{2}{2} \quad \frac{3}{3}$

- CONNECTORS AT 2 ENDS:
"T" USB3.0 A TYPE FEMALE TO
USB3.0 A TYPE FEMALE
- CABLE LENGTH IN METER:
0.5M, 1M, 2M, 3M, ...etc.
- CABLE COLOR:
"U" BLUE

USB3.0 B/F TO USB3.0 B/M CABLE

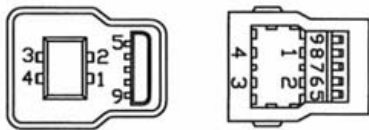
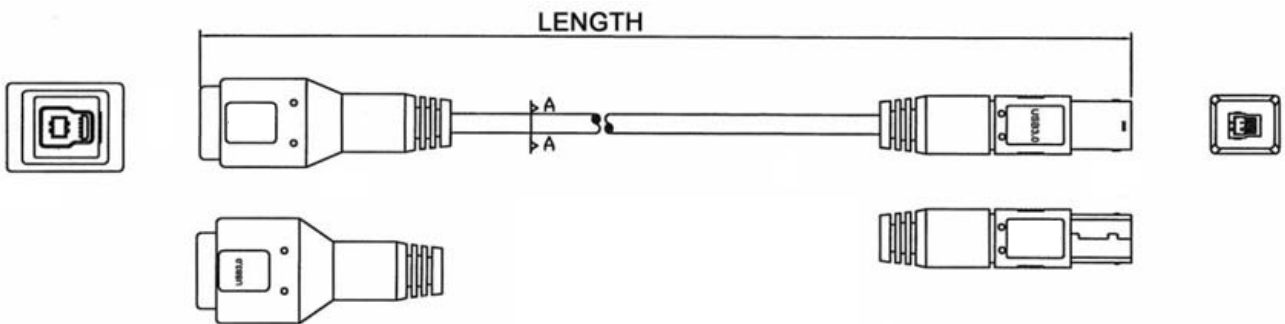

USB3.0 BF	USB3.0 BM	COLOR
1	1	RED(PWR)
2	2	WHITE(UTP_D-)
3	3	GREEN(UTP_D+)
4	4	BLACK(GND_PWRrt)
5	5	YELLOW(SDP1-)
6	6	BLUE(SDP1+)
7	7	DRAIN(SDP1_Drain) (SDP2_Drain)
8	8	ORANGE(SDP2-)
9	9	PURPLE(SDP2+)
SHELL	SHELL	BRAID

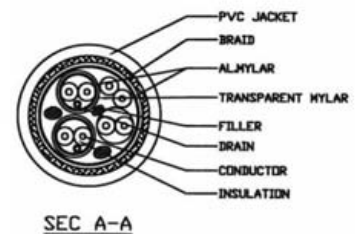

ORDERING INFORMATION:

P/N **K 0 7 U - x x M U**
 1 2 3

- CONNECTORS AT 2 ENDS:
"U" USB3.0 B TYPE FEMALE TO
USB3.0 B TYPE MALE
- CABLE LENGTH IN METER:
0.5M, 1M, 2M, 3M, ...etc.
- CABLE COLOR:
"U" BLUE

USB3.0 B/F TO USB3.0 B/F CABLE

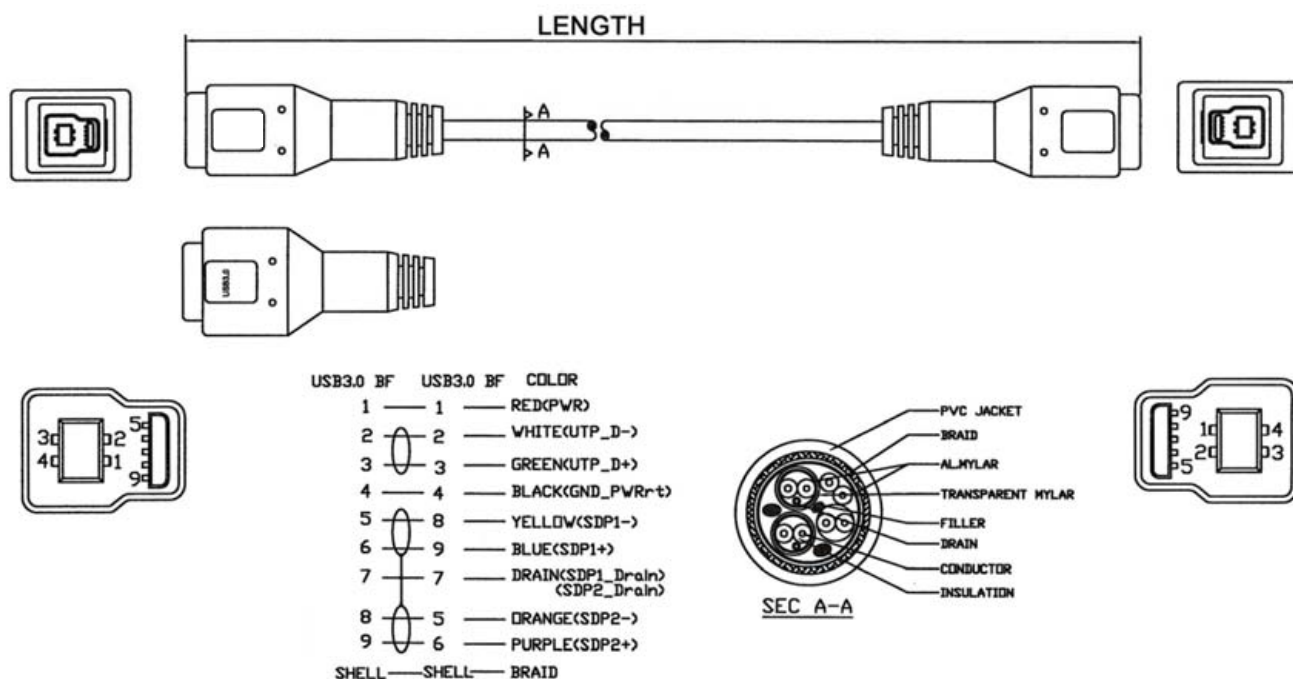

ORDERING INFORMATION:

P/N **K 0 7 V - x x M U**
1 2 3

1. CONNECTORS AT 2 ENDS:
"V" USB3.0 B TYPE FEMALE TO
USB3.0 B TYPE FEMALE
2. CABLE LENGTH IN METER:
0.5M, 1M, 2M, 3M, ...etc.
3. CABLE COLOR:
"U" BLUE

USB3.0 A/M TO USB3.0 B/F CABLE

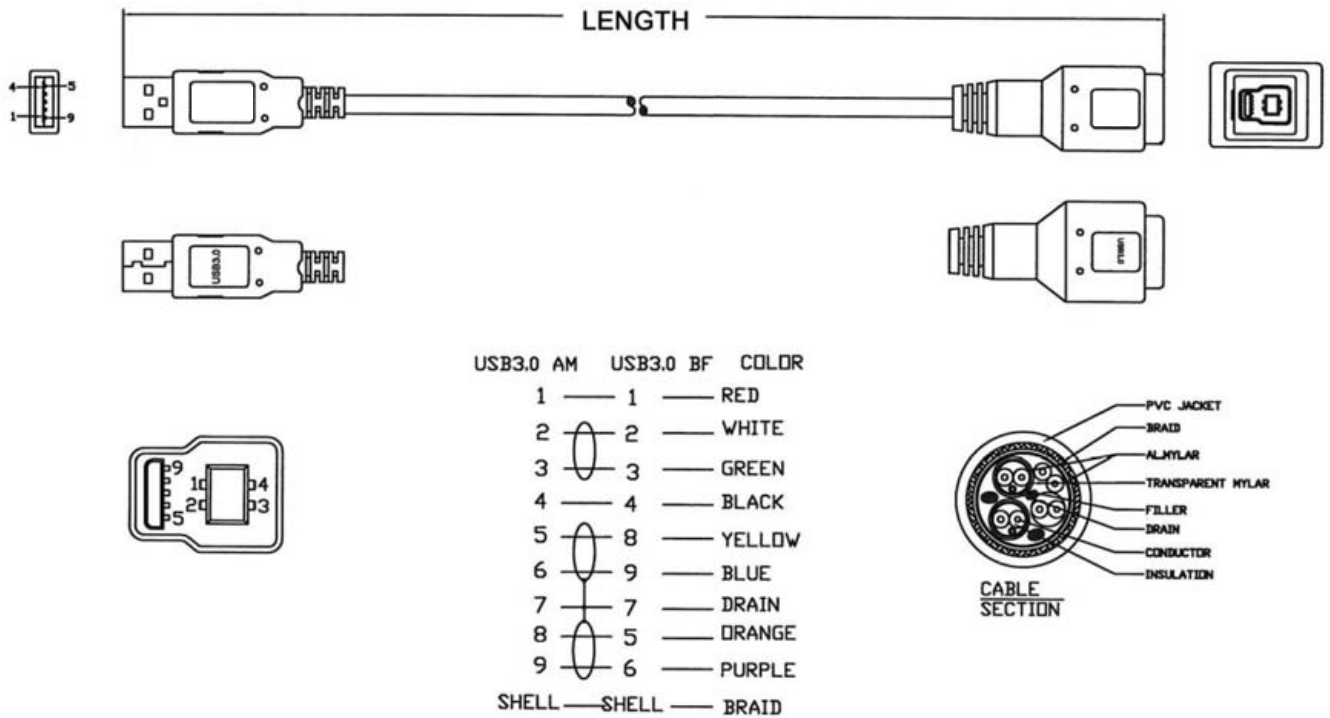

ORDERING INFORMATION:

P/N **K 0 7 W - x x M U**
 1 2 3

- CONNECTORS AT 2 ENDS:
 "W" USB3.0 A TYPE MALE TO
 USB3.0 B TYPE FEMALE
- CABLE LENGTH IN METER:
 0.5M, 1M, 2M, 3M, ...etc.
- CABLE COLOR:
 "U" BLUE

USB3.0 A/F TO USB3.0 B/F CABLE

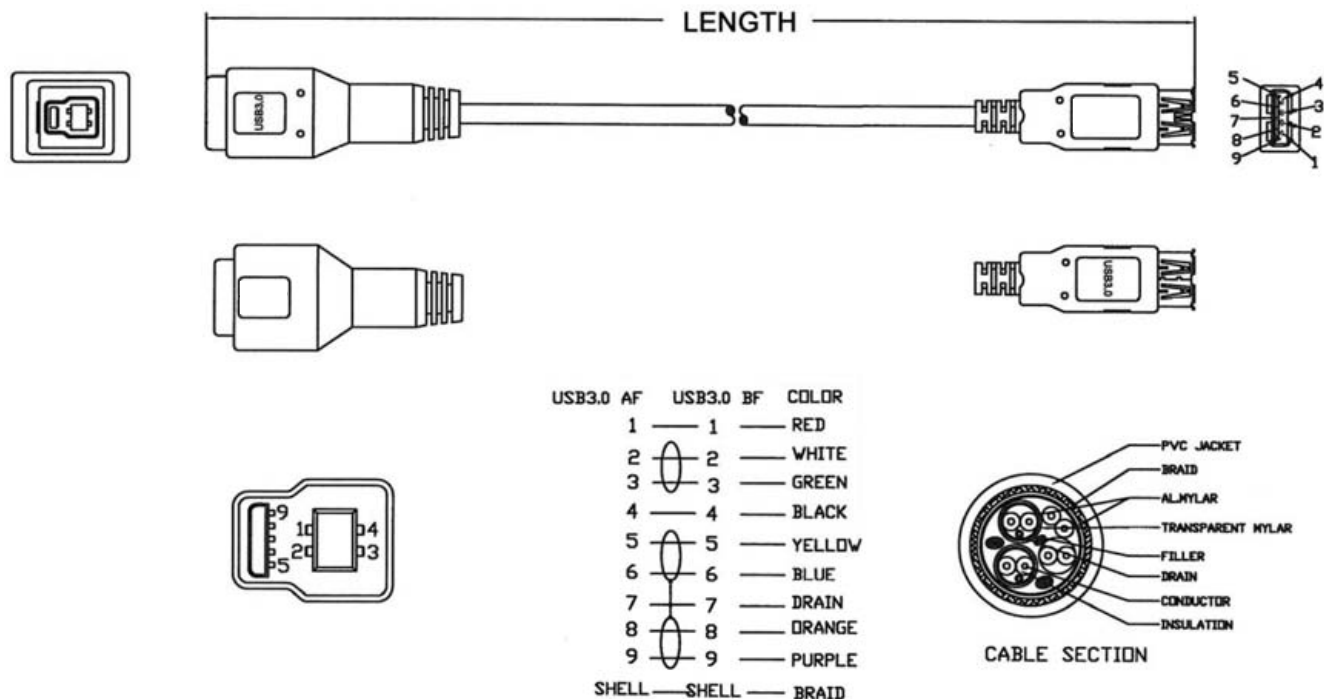

ORDERING INFORMATION:

P/N **K 0 7 Y - x x M U**
1 2 3

- CONNECTORS AT 2 ENDS:
"Y" USB3.0 A TYPE FEMALE TO
USB3.0 B TYPE FEMALE
- CABLE LENGTH IN METER:
0.5M, 1M, 2M, 3M, ...etc.
- CABLE COLOR:
"U" BLUE

USB3.0 A/F TO USB3.0 B/M CABLE

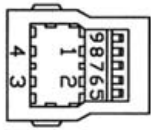
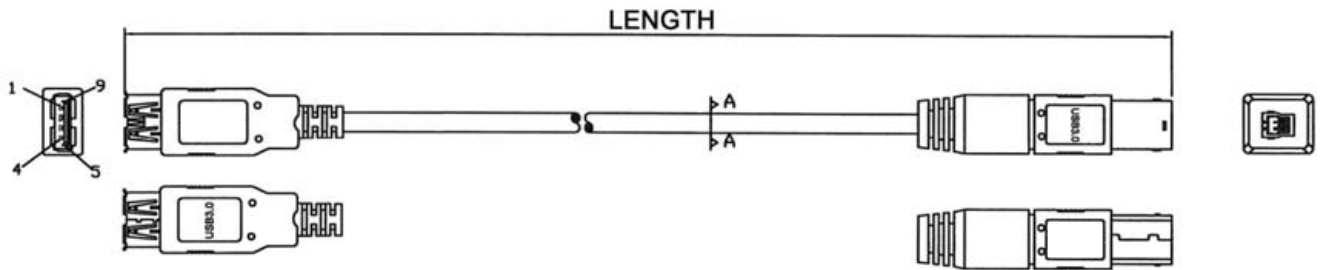

USB3.0 AF	USB3.0 BM	COLOR
1	1	RED
2	2	WHITE
3	3	GREEN
4	4	BLACK
5	8	YELLOW
6	9	BLUE
7	7	DRAIN
8	5	ORANGE
9	6	PURPLE
SHELL	SHELL	BRAID

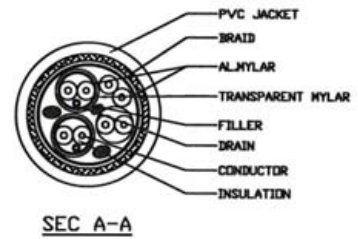

ORDERING INFORMATION:

P/N **K 0 7 Z - x x M U**
1 2 3

- CONNECTORS AT 2 ENDS:
"Z" USB3.0 A TYPE FEMALE TO
USB3.0 B TYPE MALE
- CABLE LENGTH IN METER:
0.5M, 1M, 2M, 3M, ...etc.
- CABLE COLOR:
"U" BLUE

USB3.0 A/M WITH LED TO USB3.0 A/M WITH LED CABLE

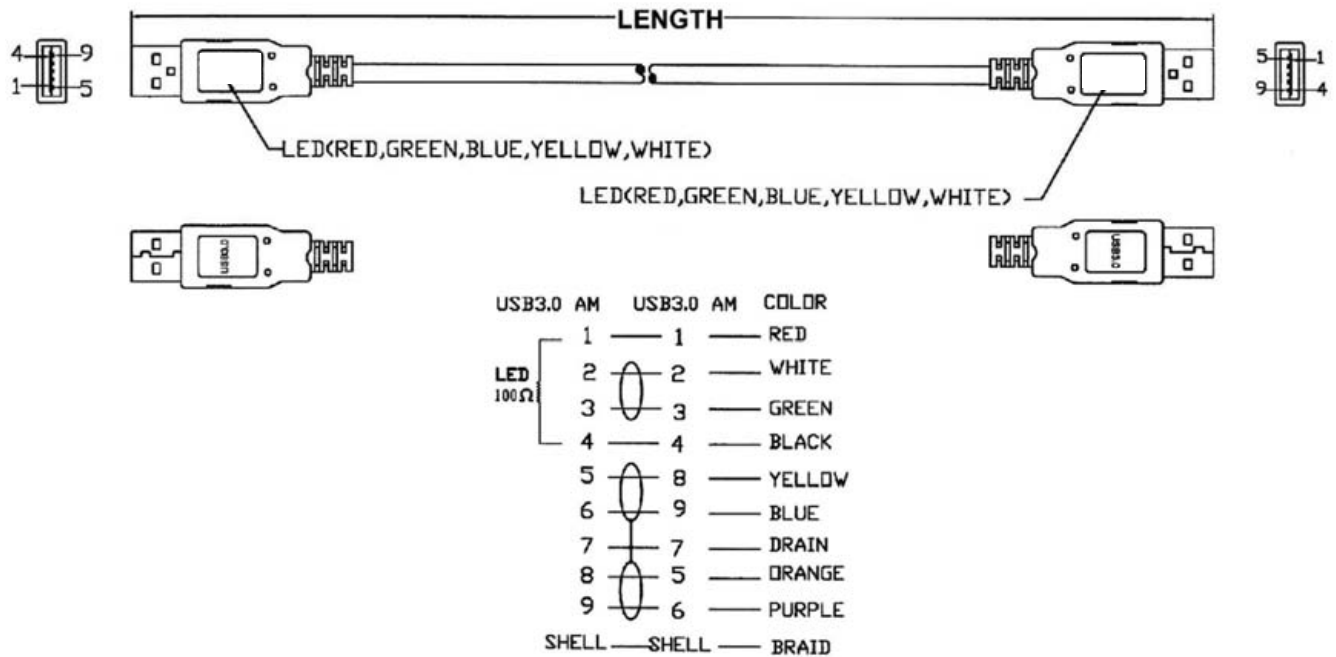

ORDERING INFORMATION:

P/N K 0 7 LM - x x x M U

1 2 3 4 5

1. CONNECTORS AT 2 ENDS:
"LM" USB3.0 A TYPE MALE WITH LED TO
USB3.0 A TYPE MALE WITH LED
2. COLOR OF LED AT END AM &
3. COLOR OF LED AT END AM
"R" RED
"Y" YELLOW
"N" GREEN
"W" WHITE
"U" BLUE
4. CABLE LENGTH IN METER:
0.5M, 1M, 2M, 3M, ...etc.
5. CABLE COLOR:
"U" BLUE

USB3.0 A/M WITH LED TO USB3.0 A/F WITH LED CABLE

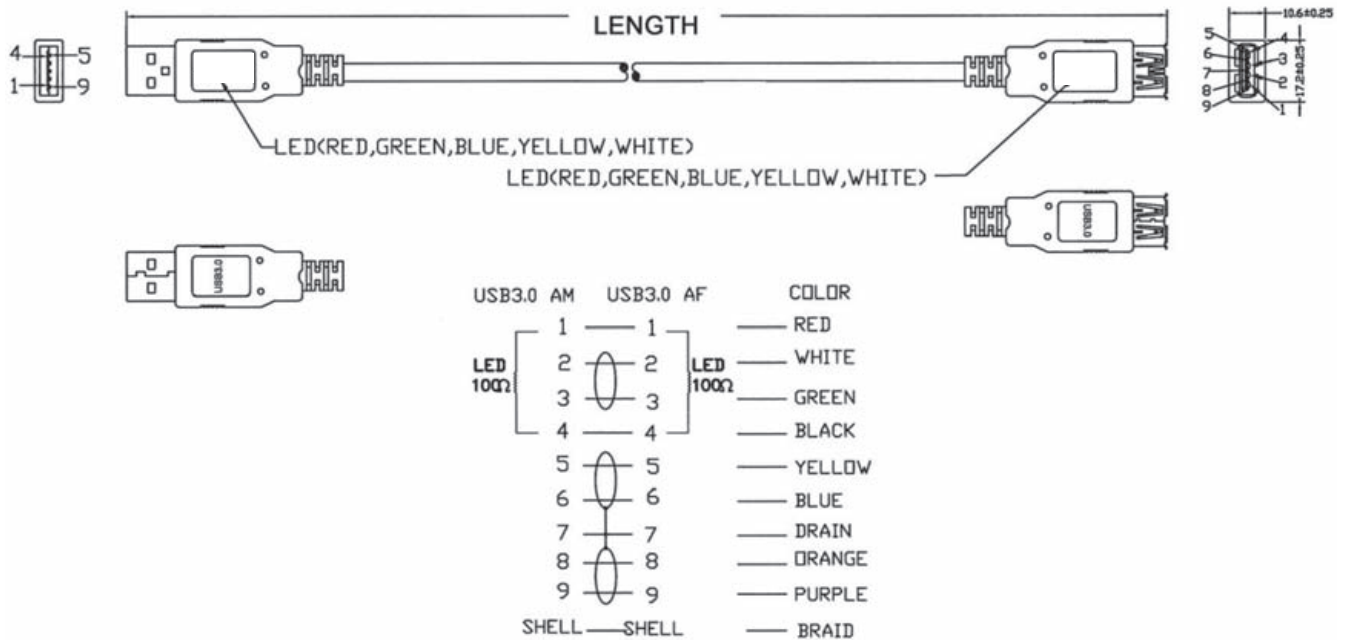

ORDERING INFORMATION:

P/N **K 0 7 L Q - x x x x M U**

1
2
3
4
5

1. CONNECTORS AT 2 ENDS:
"LQ" USB3.0 A TYPE MALE WITH LED TO
USB3.0 A TYPE FEMALE WITH LED
2. COLOR OF LED AT END AM &
3. COLOR OF LED AT END AF
"R" RED
"Y" YELLOW
"N" GREEN
"W" WHITE
"U" BLUE
4. CABLE LENGTH IN METER:
0.5M, 1M, 2M, 3M, ...etc.
5. CABLE COLOR:
"U" BLUE

USB3.0 A/F WITH LED TO USB3.0 A/F WITH LED CABLE

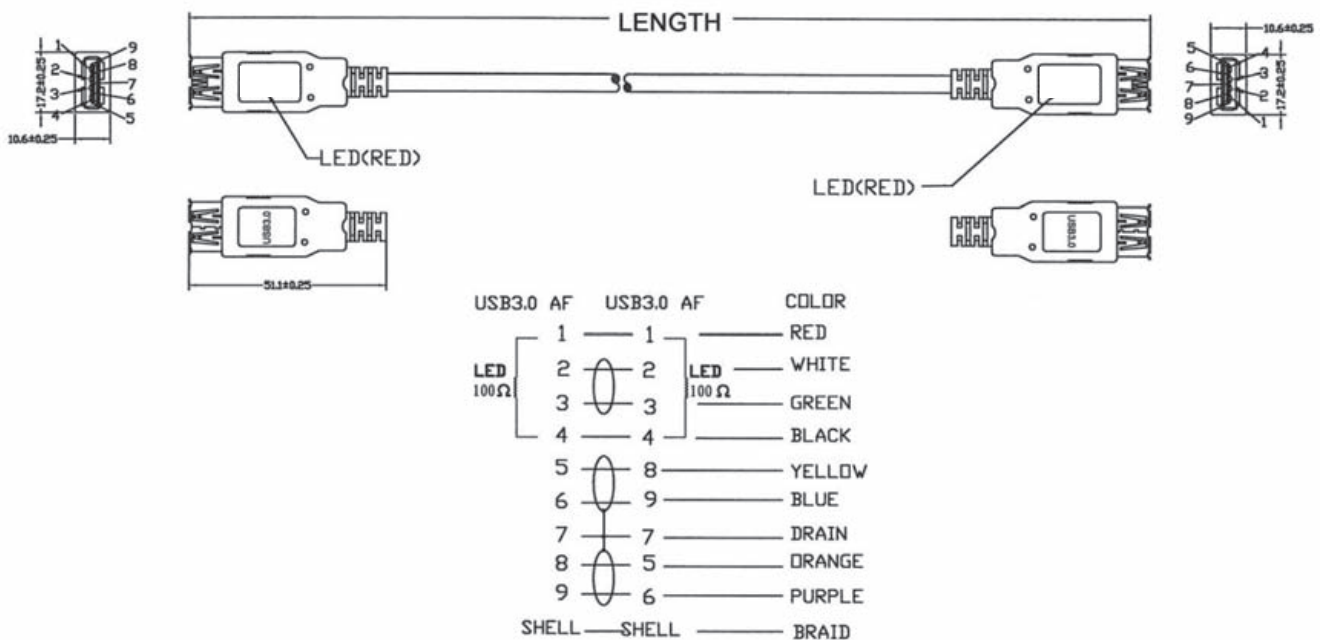

ORDERING INFORMATION:

P/N **K 0 7** LT - x x x x **M U**

1 2 3 4 5

1. CONNECTORS AT 2 ENDS:
"LT" USB3.0 A TYPE FEMALE WITH LED TO
USB3.0 A TYPE FEMALE WITH LED
2. COLOR OF LED AT END AF &
3. COLOR OF LED AT END AF
"R" RED
"Y" YELLOW
"N" GREEN
"W" WHITE
"U" BLUE
4. CABLE LENGTH IN METER:
0.5M, 1M, 2M, 3M, ...etc.
5. CABLE COLOR:
"U" BLUE

USB3.0 B/M WITH LED TO USB3.0 B/F WITH LED CABLE

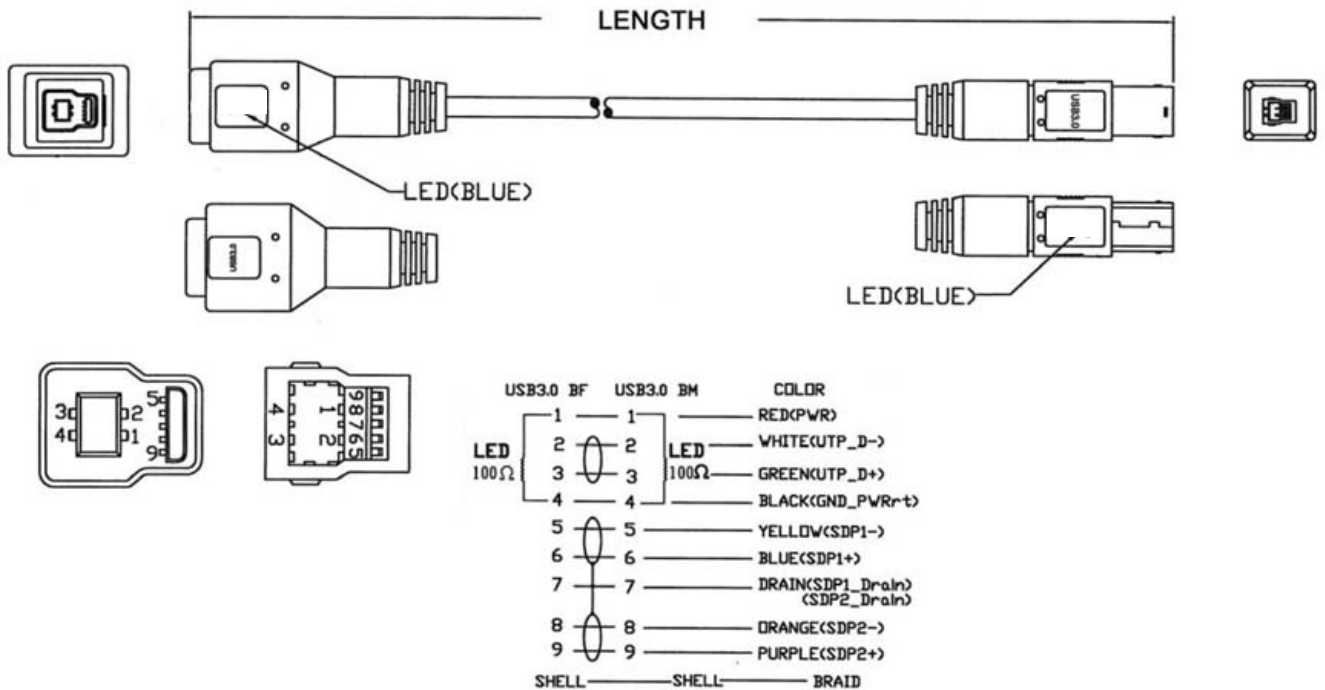

ORDERING INFORMATION:

P/N K 0 7 LU - x x x x M U

1 2 3 4 5

1. CONNECTORS AT 2 ENDS:
"LU" USB3.0 B TYPE MALE WITH LED TO
USB3.0 B TYPE FEMALE WITH LED
2. COLOR OF LED AT END BM &
3. COLOR OF LED AT END BF
"R" RED
"Y" YELLOW
"N" GREEN
"W" WHITE
"U" BLUE
4. CABLE LENGTH IN METER:
0.5M, 1M, 2M, 3M, ...etc.
5. CABLE COLOR:
"U" BLUE

USB3.0 B/F WITH LED TO USB3.0 B/F WITH LED CABLE

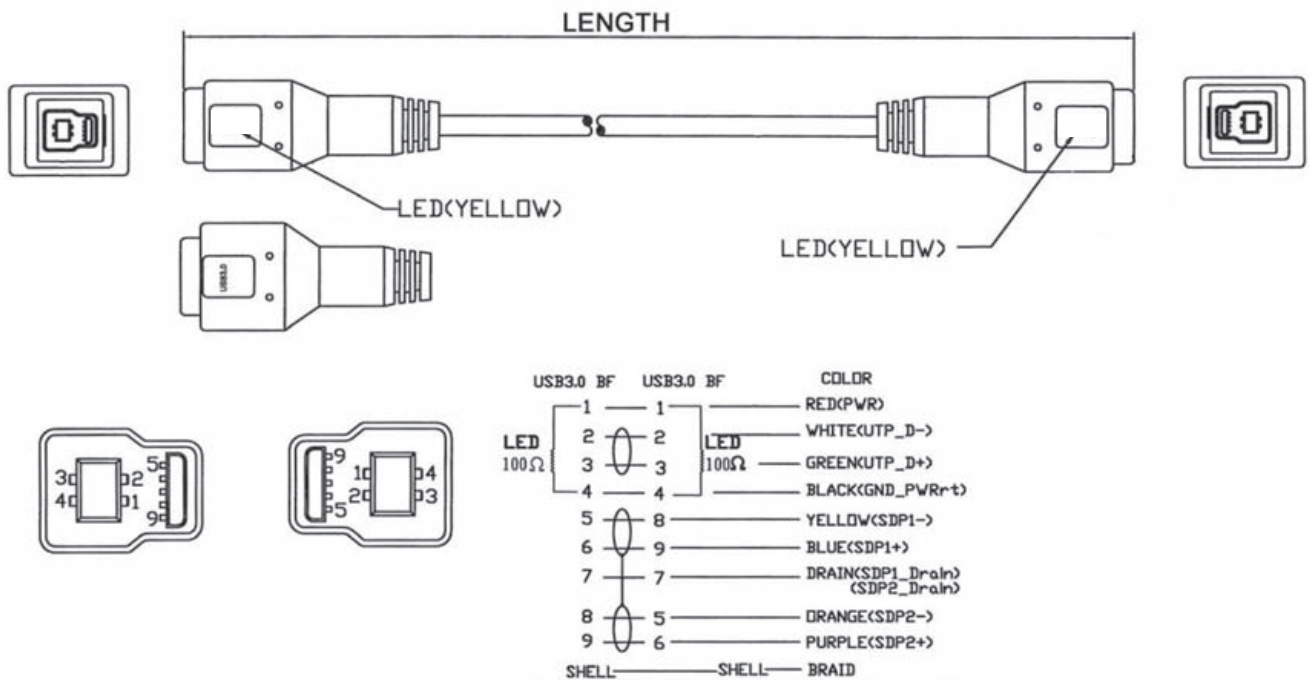

ORDERING INFORMATION:

P/N K 0 7 L V - x x x x M U

1 2 3 4 5

1. CONNECTORS AT 2 ENDS:
"LV" USB3.0 B TYPE FEMALE WITH LED TO
USB3.0 B TYPE FEMALE WITH LED
2. COLOR OF LED AT END BF &
3. COLOR OF LED AT END BF
"R" RED
"Y" YELLOW
"N" GREEN
"W" WHITE
"U" BLUE
4. CABLE LENGTH IN METER:
0.5M, 1M, 2M, 3M, ...etc.
5. CABLE COLOR:
"U" BLUE

USB3.0 A/M WITH LED TO USB3.0 B/F WITH LED CABLE

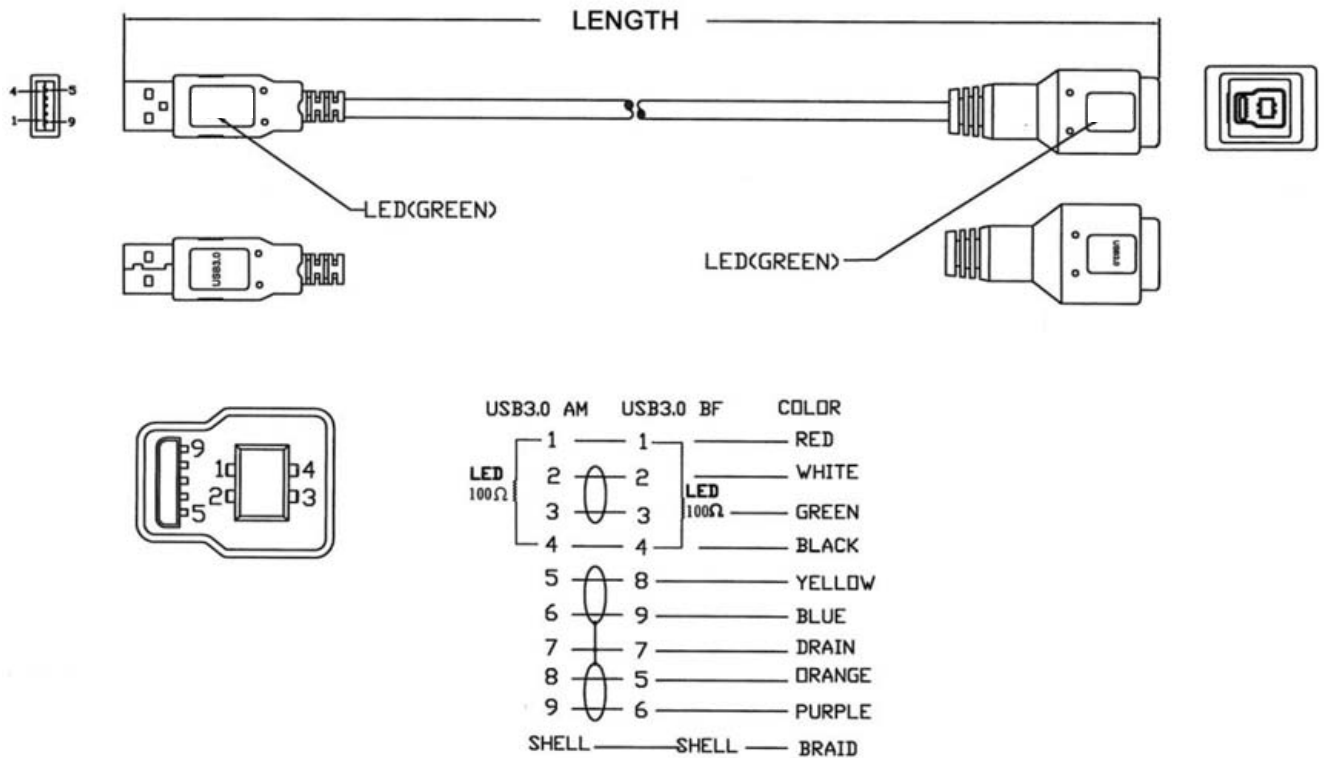

ORDERING INFORMATION:

P/N **K 0 7** L W - x x x x **M U**

1 2 3 4 5

1. CONNECTORS AT 2 ENDS:
"LW" USB3.0 A TYPE MALE WITH LED TO
USB3.0 B TYPE FEMALE WITH LED
2. COLOR OF LED AT END AM &
3. COLOR OF LED AT END BF
"R" RED
"Y" YELLOW
"N" GREEN
"W" WHITE
"U" BLUE
4. CABLE LENGTH IN METER:
0.5M, 1M, 2M, 3M, ...etc.
5. CABLE COLOR:
"U" BLUE

USB3.0 A/F WITH LED TO USB3.0 B/F WITH LED CABLE

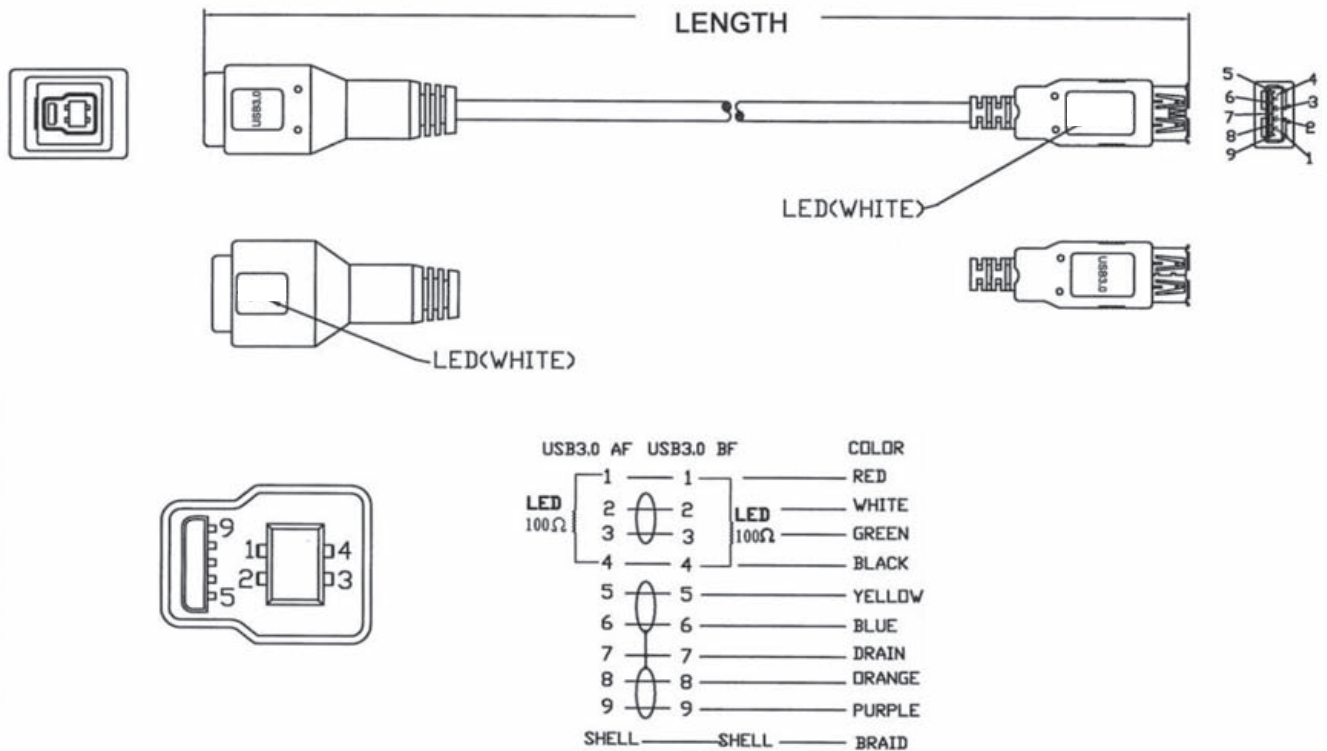

ORDERING INFORMATION:

P/N K 0 7 LY - x x x x M U

1 2 3 4 5

1. CONNECTORS AT 2 ENDS:
"LY" USB3.0 A TYPE FEMALE WITH LED TO
USB3.0 B TYPE FEMALE WITH LED
2. COLOR OF LED AT END AF &
3. COLOR OF LED AT END BF
"R" RED
"Y" YELLOW
"N" GREEN
"W" WHITE
"U" BLUE
4. CABLE LENGTH IN METER:
0.5M, 1M, 2M, 3M, ...etc.
5. CABLE COLOR:
"U" BLUE

USB3.0 A/F WITH LED TO USB3.0 B/M WITH LED CABLE

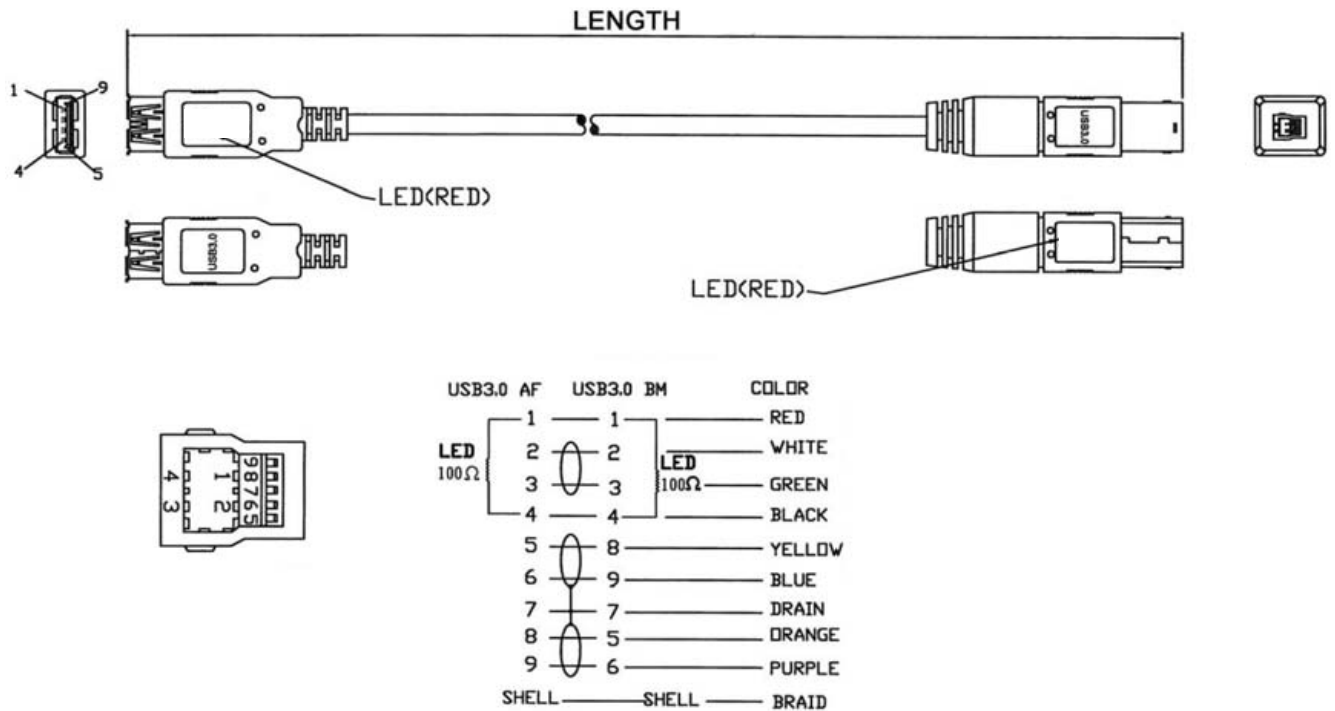

ORDERING INFORMATION:

P/N K 0 7 L Z - x x x x M U

- CONNECTORS AT 2 ENDS:
"LZ" USB3.0 A TYPE FEMALE WITH LED TO
USB3.0 B TYPE MALE WITH LED
- COLOR OF LED AT END AF &
- COLOR OF LED AT END BM
"R" RED
"Y" YELLOW
"N" GREEN
"W" WHITE
"U" BLUE
- CABLE LENGTH IN METER:
0.5M, 1M, 2M, 3M, ...etc.
- CABLE COLOR:
"U" BLUE

USB3.0 R/A A/F TO USB3.0 R/A B/M CABLE (1)

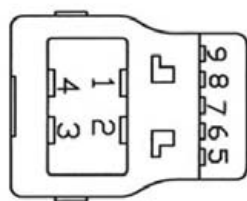
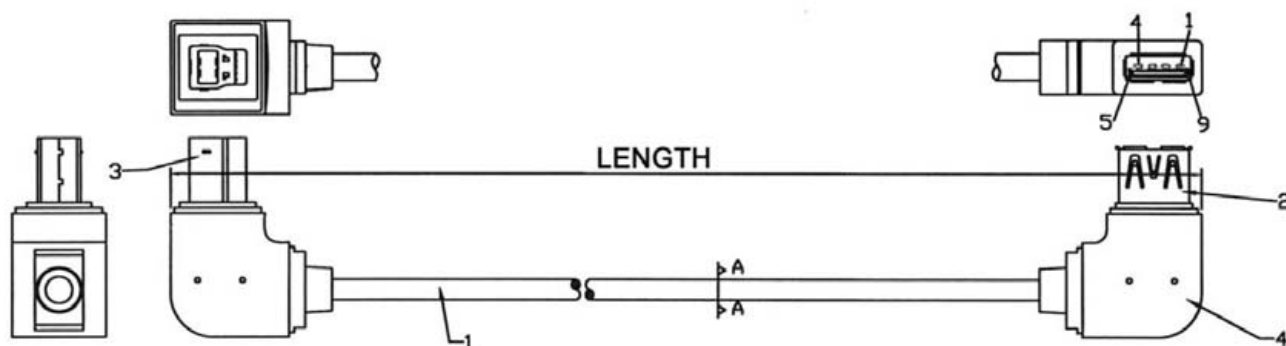

USB3.0 AF	USB3.0 BM	COLOR
1	1	RED
2	2	WHITE
3	3	GREEN
4	4	BLACK
5	8	YELLOW
6	9	BLUE
7	7	DRAIN
8	5	ORANGE
9	6	PURPLE
SHELL	SHELL	BRAID

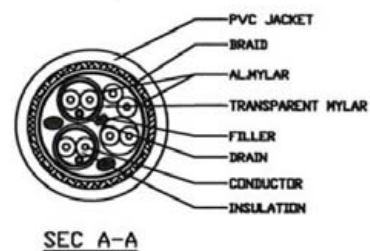

ORDERING INFORMATION:

P/N **K 0 7 R Z - U x x M U**
 1 2 3 4

- CONNECTORS AT 2 ENDS:
"RZ" USB3.0 RIGHT ANGLE B TYPE MALE TO
USB3.0 RIGHT ANGLE A TYPE FEMALE
- TURN DIRECTION OF CONNECTORS:
"U" TURN TO UP
- CABLE LENGTH IN METER:
0.5M, 1M, 2M, 3M, ...etc.
- CABLE COLOR:
"U" BLUE

USB3.0 R/A A/F TO USB3.0 R/A B/M CABLE (2)

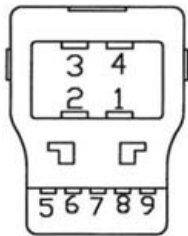
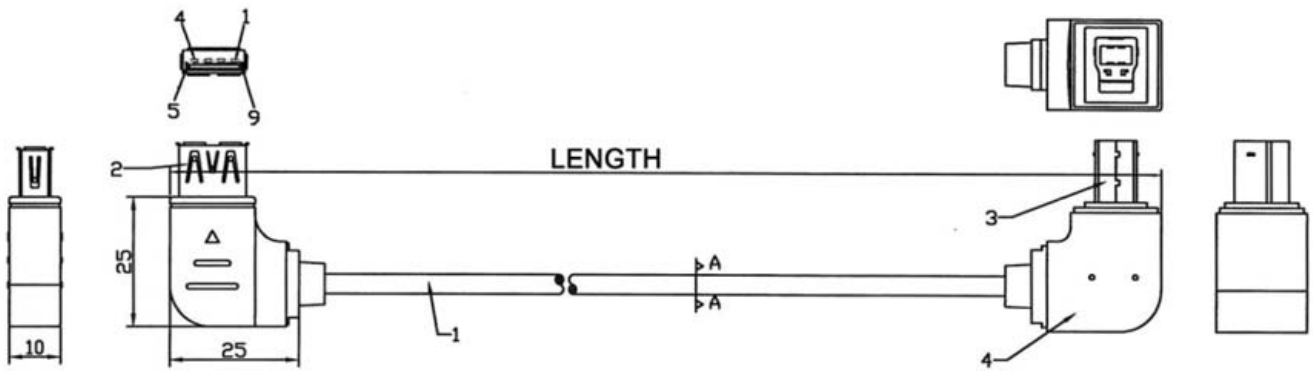

USB3.0 AF	USB3.0 BM	COLOR
1	1	RED
2	2	WHITE
3	3	GREEN
4	4	BLACK
5	8	YELLOW
6	9	BLUE
7	7	DRAIN
8	5	ORANGE
9	6	PURPLE
SHELL	SHELL	BRAID

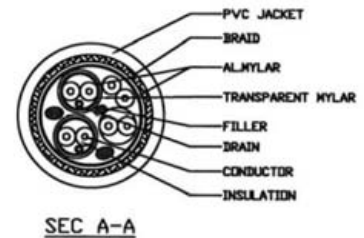

ORDERING INFORMATION:

P/N **K 0 7 R Z - R x x M U**
 1 2 3 4

- CONNECTORS AT 2 ENDS:
"RZ" USB3.0 RIGHT ANGLE B TYPE MALE TO
USB3.0 RIGHT ANGLE A TYPE FEMALE
- TURN DIRECTION OF CONNECTORS:
"R" TURN TO RIGHT
- CABLE LENGTH IN METER:
0.5M, 1M, 2M, 3M, ...etc.
- CABLE COLOR:
"U" BLUE

USB3.0 R/A A/F TO USB3.0 R/A B/M CABLE (3)

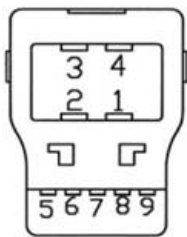
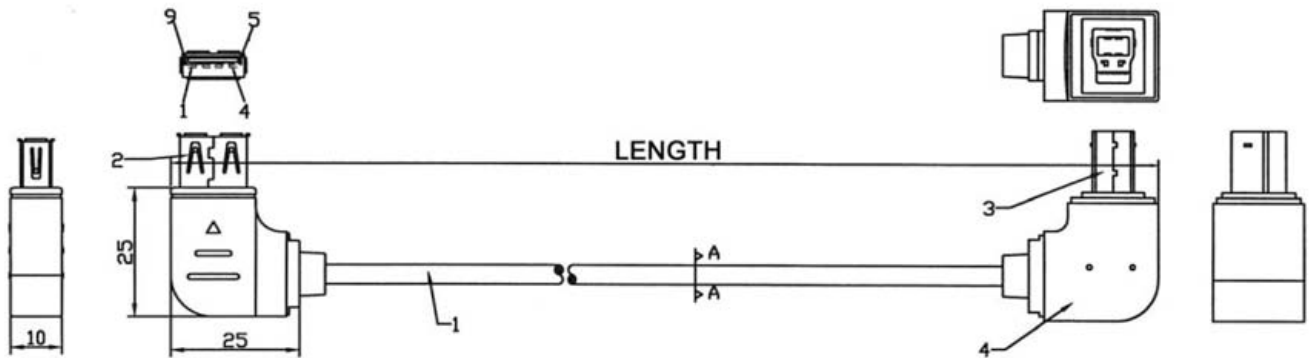

USB3.0 AF	USB3.0 BM	COLOR
1	1	RED
2	2	WHITE
3	3	GREEN
4	4	BLACK
5	8	YELLOW
6	9	BLUE
7	7	DRAIN
8	5	ORANGE
9	6	PURPLE
SHELL	SHELL	BRAID

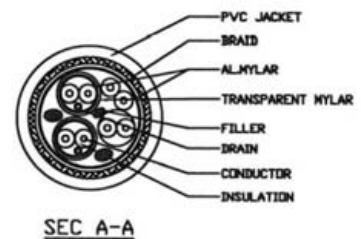

ORDERING INFORMATION:

P/N **K 0 7 R Z** - $\frac{L}{1}$ $\frac{x x}{2}$ $\frac{M}{3}$ $\frac{U}{4}$

- CONNECTORS AT 2 ENDS:
"RZ" USB3.0 RIGHT ANGLE B TYPE MALE TO
USB3.0 RIGHT ANGLE A TYPE FEMALE
- TURN DIRECTION OF CONNECTORS:
"L" TURN TO LEFT
- CABLE LENGTH IN METER:
0.5M, 1M, 2M, 3M, ...etc.
- CABLE COLOR:
"U" BLUE

USB3.0 R/A A/F TO USB3.0 R/A B/M CABLE (4)

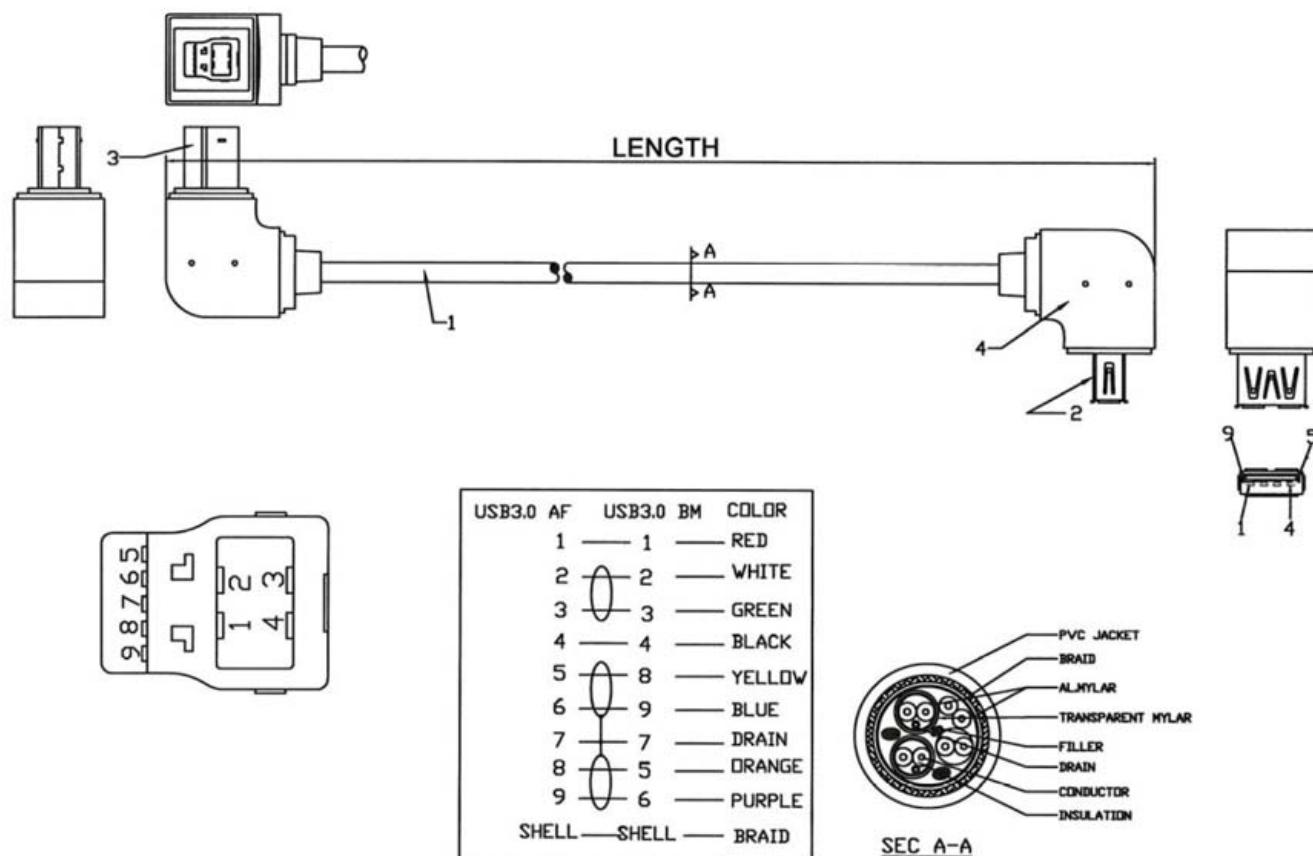

ORDERING INFORMATION:

P/N K 0 7 R Z - D x x M U
 1 2 3 4

- CONNECTORS AT 2 ENDS:
"RZ" USB3.0 RIGHT ANGLE B TYPE MALE TO
USB3.0 RIGHT ANGLE A TYPE FEMALE
- TURN DIRECTION OF CONNECTORS:
"D" TURN TO DOWN
- CABLE LENGTH IN METER:
0.5M, 1M, 2M, 3M, ...etc.
- CABLE COLOR:
"U" BLUE